

CHILTON'S **MOTORCYCLE** **and ATV** **REPAIR MANUAL** **1945-85**

Editorial Director	Alan F. Turner
Executive Editor	Kerry A. Freeman, S.A.E.
Senior Editor	Richard J. Rivele, S.A.E.
Senior Editor	Joseph F. Pellicciotti
Editorial Staff	W. Calvin Settle, Jr. John M. Baxter Martin Gunther Tony Molla, S.A.E. Michael Newsome Richard Smith Ron Webb John J. Cantwell Dean F. Morgantini, S.A.E. Robin S. Miller Margaret A. Stoner Cynthia Fiore William Gaskins
Production Manager	
Manager Editing and Design	
Art and Production Coordinator	
Supervisor Mechanical Pasteup	
Mechanical Artists	
OFFICERS	
President	Lawrence A. Fornasieri
Vice President & General Manager	John P. Kushnerick

CHILTON BOOK COMPANY
Chilton Way, Radnor, PA 19089

Manufactured by USA
© 1986 by Chilton Book Company
ISBN 0-8019-7635-9
Library of Congress Card No. 85-47957
1234567890 5432109876

Honda Four-Stroke Singles

MODEL COVERAGE

Z50A	CT70H	C90	CB100, K1-K3	CL125S
C65/M	SL70	CD90	CL100/S	SL125
S65	XR75	CT90	SL100	TL125, K1-K2
C70/M	S90	SL90	CB125S/S1/S2	TL125 (76)
CL70	CL90/LK	ST90	CD125S	CB125S (76)

INDEX

MAINTENANCE	183	Splitting the Crankcases	206
Oil Changes and Lubrication	183	Transmission.....	207
Engine	183	Kick-Starter	207
Front Forks.....	184	Crankshaft	207
Chassis Lubrication.....	184	Crankcase Assembly.....	207
Service Checks and Adjustments	184	Engine and Transmission Specifications	209
Drive Chain	184	Engine Torque Specifications	211
Centrifugal Clutch	184	General Torque Specifications.....	211
Manual Clutch	185		
Throttle Cable	185	LUBRICATION SYSTEM	212
Brakes	185	Oil Pump Service	212
Steering Stem Bearings	185	Oil Pump Specifications	215
		FUEL SYSTEM	216
FUEL SYSTEM	185	Carburetor	216
Air Cleaner Service.....	186	Fuel Petcock and Lines	218
Decarbonization	186	Carburetor Specifications	219
Headlight Adjustment	186		
Recommended Lubricants.....	187	ELECTRICAL SYSTEM	219
Periodic Maintenance	187	Ignition Circuit	219
Maintenance Data	187	Charging Circuit	220
Battery Specifications	188	Starting System.....	221
		Wiring Diagrams.....	222
TUNE-UP	188		
Cam Chain Adjustment	188	CHASSIS	239
Valve Adjustment	189	Wheels.....	239
Contact Breaker Points.....	189	Front Disc Brake.....	242
Ignition Timing.....	191	Front Forks.....	243
Carburetor	193	Steering Stem Assembly	245
Tune-Up Specifications.....	190	Bearing Adjustment	245
		Removal	246
ENGINE AND TRANSMISSION	193	Inspection.....	246
Engine Removal and Installation	193	Installation.....	246
Top End.....	195	Rear Shocks	246
Top End Service	200	Swing Arm	247
Crankcase Cover Components	200	Chassis Specifications	247
Right Crankcase Cover Components.....	200	Chassis Torque Specifications.....	247
Left Crankcase Cover Components	203		
Component Inspection.....	205		
Lower End and Transmission	206		

NOTE: See supplement to this section for 1982 and later information.

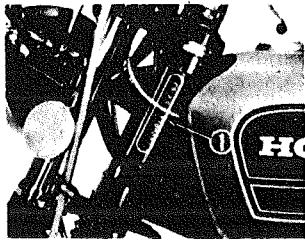

Frame serial number location

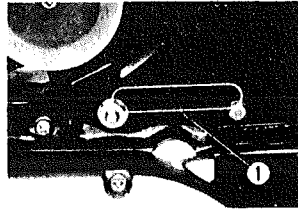

Frame serial number location

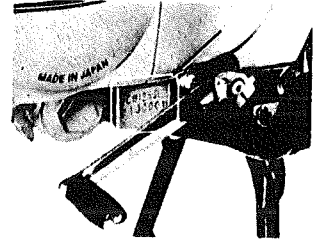

Engine serial number location

NOTE: *Common maintenance procedures are explained in detail in "General Information."*

OIL CHANGES AND LUBRICATION

Checking Oil

On all models the oil level is checked by means of the dipstick incorporated into the filler cap. The filler cap is located in the right crankcase cover. To check the oil:

1. Start the engine and allow it to warm up for a few minutes.
2. Hold the motorcycle upright on level ground, remove the dipstick and wipe it clean.
3. Reinsert the dipstick, allowing the dipstick cap to rest on the top of the threads of its hole. The oil level should be between the maximum and minimum marks on the dipstick.

If the level is below the minimum mark on the dipstick, add enough oil through the hole to bring the level up to the maximum mark.

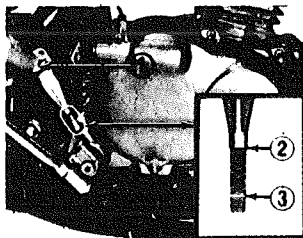

Engine oil level must be maintained between the upper (2) and lower (3) dipstick level marks

Changing Oil

1. Change the engine oil every 1,500 miles, or on machines without a speedometer, every 30 operating days or every 3 months. Use high detergent motor oil service rated "SE" only.

NOTE: *The oil change interval is based on normal operating conditions. If the motorcycle is used under severe conditions (i.e., racing, high-speed operation, stop-and-go riding, dusty conditions, operation in cold weather, etc.), changes should be made more frequently. This is also true if the machine is used infrequently especially during winter months.*

2. Run the engine until it is at normal operating temperature. Oil must always

be changed when the engine is warm.

3. Remove the dipstick, and place a pan beneath the engine to catch the oil. Remove the drain plug and allow the oil to drain for several minutes. Kick the engine over a few times with the kick-starter to remove any oil remaining in the delivery system.

4. Replace the drain plug and tighten it securely.

5. Remove and clean the filter, if applicable, as outlined below.

6. Fill the sump with the correct amount and grade of oil. Refer to the charts at the end of this section. Run the engine for a minute or so, then shut it off and let it sit for one minute and check the oil level; add oil as necessary until the level is correct.

NOTE: *The use of oil additives is not recommended, as they may cause clutch slippage.*

Oil Filter

Two types of oil filter are used: a filter screen and a centrifugal filter. The centrifugal oil filter is located on the right-side of the crankshaft on the XR75 and 100/125 cc machines, or in the clutch on other models.

50-90 cc models have the filter screen in the crankcase under the right crankcase cover, while on the 100/125 cc bikes, the filter screen is beneath a cap on the left-side of the crankcase sump.

On 100/125 cc models, the filter screen is easily accessible, and should therefore be cleaned at every oil change. The screen on other models and the centrifugal filter on all models is reached after removing the right crankcase cover, and service should be performed at every 6,000 miles or 1 year intervals.

OIL FILTER SCREEN

100/125 cc Models

1. Drain the oil as previously described.

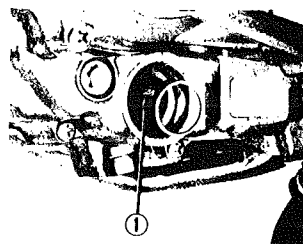

Oil filter screen location (100/125)

2. Remove the oil filter screen cap. Take out the spring and the filter screen.

3. Wash the screen in solvent; remove any trapped particles; blow dry.

4. Check the screen for punctures or a crushed condition; replace it if necessary. Install the screen, spring, and cap. Tighten firmly.

50-90 cc Models

Service the filter screen at the same time as the centrifugal oil filter. This involves removing the right crankcase cover. See below.

CENTRIFUGAL OIL FILTER

All Models

1. Drain the oil as previously described.

2. Remove the skid plate, if fitted.

3. Remove the kick-starter lever and footpeg(s). Disconnect the tach and clutch cables if these are connected to the cover.

4. Loosen the rear brake adjusting nut so that the brake pedal can be depressed enough to allow the crankcase cover to clear.

5. Place a pan beneath the right crankcase cover. Loosen the cover screws with an impact driver and remove them. Tap the cover gently with a plastic mallet if necessary to free it, and remove the cover.

6. On 100/125 cc models, and the XR75, remove the centrifugal oil filter rotor cover.

7. On 50-90 cc models, remove the clutch housing cover.

8. Clean any metal particles out of the filter with a clean rag. Install the filter cover.

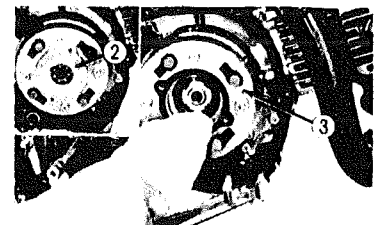

Models which have the clutch on the crankshaft have the centrifugal oil filter located in the clutch center beneath the housing cover (2)

9. On 50-90 cc models, remove the filter screen and clean it in solvent. Check it for punctures and replace it if damaged.

Honda 4-Stroke Singles

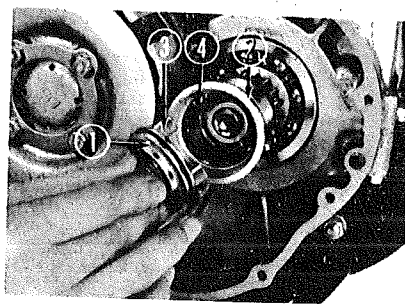

Be sure to line up the tabs (3) on the filter cap with the slots (4) in the rotor (2) (100/125)

10. Before installing the crankcase cover, check the condition of the gasket, and replace it if nicked or damaged.

Front Forks

1. Fork oil should be changed every 6,000 miles or every 12 months.

2. ATF is recommended for all forks, although any quality oil designed for motorcycle forks is acceptable.

Motor oils of varying viscosities (10W-40, 20W, 30W) can also be used.

Various type of oils may not be compatible, however. If you are going to change the *type* of fork oil, it is best to flush the fork legs with a solvent before adding the new type oil. Do not use gasoline, as this may damage rubber parts.

3. To drain the fork oil, remove the drain plug at the lower portion of one of the fork sliders. Pump the slider up and down several times until all the old oil is expelled. Then turn the forks all the way to the right to completely drain the right fork leg, or to the left for the left fork leg. Check the condition of the drain plug gasket. Replace it if necessary. Refit and tighten the drain plug.

4. Repeat the procedure with the other fork leg.

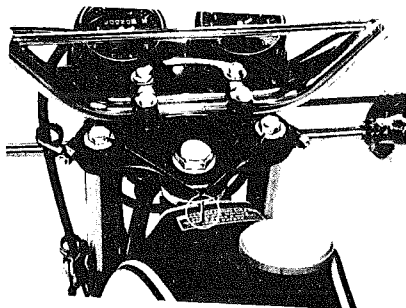

Fork filler caps

5. Support the front wheel off the ground. Remove the fork filler cap from each fork leg. The handlebar clamps may have to be removed and the handlebars pulled back to allow access to the fork caps. Loosening the upper triple clamp pinch-bolts (if fitted) may make removal easier. On TL125K2 and later models, remove the rubber cap, press down on the plug with a phillips screwdriver, remove the snap-ring and take out the plug.

6. Add the correct quantity of oil to each fork leg. Capacities for each model are given in the "Maintenance Data" chart at the end of this section.

184

Chassis Lubrication

1. The swing arm pivot on some models is fitted with a grease nipple. This item should be lubricated with a good grade of chassis grease every 3,000 miles. Grease should be applied until some of it shows at either end of the swing arm.

2. Wheel and steering head bearings are lubricated with bearing grease. This should be done every 6,000 miles. Refer to the "Chassis" section for procedures.

SERVICE CHECKS AND ADJUSTMENTS

Drive Chain

1. The chain should have about $\frac{3}{4}$ in. (20 mm) of total up-and-down free-play measured in the middle of the lower chain run.

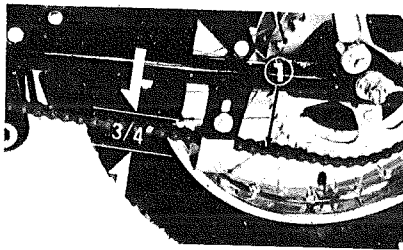

Chain free-play is measured in the middle of the lower chain run and is the total up-and-down movement of the chain

2. Before checking or adjusting the chain slack, the following conditions should be met:

a. A support should be placed under the engine if necessary, so that the rear wheel is off the ground;

b. The transmission should be placed in Neutral;

c. The chain should be clean and well lubricated;

d. The chain should have been checked for any tight spots by slowly rotating the wheel and checking for variances in the chain tension. If a tight spot exists, the chain tension should be adjusted to the prescribed free-play at the tight spot. Note, however, that such a condition is indicative of a worn chain and probably sprockets which should be replaced as soon as possible.

3. To adjust the chain, first back off the rear brake adjuster nut.

4. Remove the axle nut cotter pin and loosen the axle nut several turns.

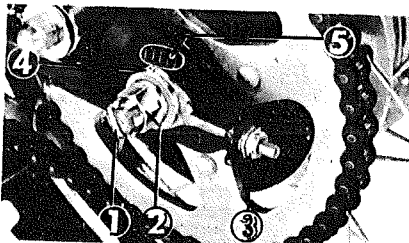

Chain adjustment: (1) cotter pin; (2) axle nut; (3) adjuster nuts; (4) adjuster alignment mark; (5) swing arm alignment marks

5. Turn each of the adjuster nuts by equal amounts until the chain tension is approximately correct.

6. Check wheel alignment by means of the aligning marks inscribed on both sides of the swing arm. Be sure that both adjusters are lined up with the same mark on each side.

7. On the TL125, the chain is adjusted by means of eccentric plates. After loosening the axle nut, turn each plate the correct number of serrations until chain tension is correct.

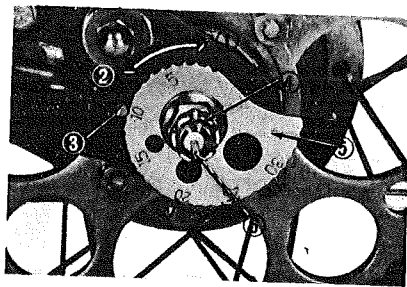

Chain adjuster, TL125: (1 and 2) direction of adjuster plate movement; (3) stud; (4) axle nut; (5) eccentric adjusting plates; (6) cotter pin

If the plates are difficult to move, either pull the wheel back by hand to move the plates off the stud, or tap the side of the tire with your hand while moving the eccentric adjusting plates.

8. Tighten the axle nut and check the chain tension. Then check that the chain has proper tension with the weight of a rider on the machine. Correct if necessary. Tighten the axle nut to the proper torque. Fit a new cotter pin.

Centrifugal Clutch

1. Models such as the Z50, ST/CT90, CT70, C70M, and several others utilize a centrifugal clutch. No adjustment is necessary if: a) the motorcycle goes smoothly into First gear without a jolt or stalling; b) the motorcycle begins to move as the throttle is opened and moving performance is satisfactory, and c) the clutch does not slip when the kick-starter is operated.

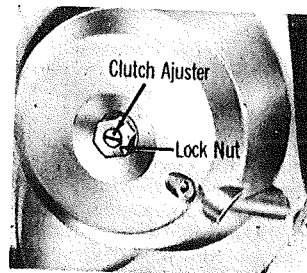

Centrifugal clutch adjuster

2. If adjustment is necessary, loosen the clutch adjusting screw locknut located on the right crankcase cover. Turn the adjusting screw about one turn clockwise (right). Then slowly turn the adjusting screw counterclockwise until resistance is felt. Stop, and turn the screw clockwise about $\frac{1}{8}$ - $\frac{1}{4}$ turn, and tighten the locknut. Check clutch operation.

Manual Clutch

1. There are two adjusters on the clutch cable. Cable free-play should be maintained at 10–20 mm (0.4–0.8 in.) of hand lever movement measured at the end of the lever.

Use the adjuster at the hand lever for routine adjustments; the one at the engine end can be used for major adjustments.

2. After adjusting the cable to the proper specification, clutch operation should be correct. Gears should be easily engaged (without excessive noise), Neutral should be found easily, and the bike should not have a tendency to creep when in gear with the clutch disengaged. If any of these symptoms are noted, or if clutch slippage is evident, adjust the clutch as follows:

SL70, CT70H, CL70, S65

1. Remove the clutch adjuster cover plate on the right crankcase cover. Run down the cable adjuster at the handlebar to give a good deal of cable free-play.

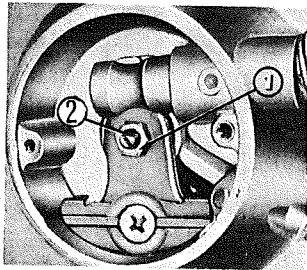

Manual clutch adjusting screw (2) and locknut (1) (70 cc)

2. Loosen the adjusting screw locknut, and turn the screw clockwise until resistance is felt. Then back it off $\frac{1}{8}$ – $\frac{1}{4}$ turn to the left. Tighten the locknut; adjust the cable free-play as previously outlined. Check clutch operation.

S90, CL90/L, SL90, TL125, 100/125 (1976 AND LATER)

Clutch adjustment is made by adjusting the cable. Use the handlebar or lower end cable adjuster to keep free-play to 10–20 mm (0.4–0.8 in.)

100/125 MODELS, (1975 AND EARLIER), XR75

1. The clutch is adjusted by means of an adjusting screw on the right crankcase cover.

2. If adjustment is necessary, run down the cable adjuster on the handlebar until there is excess play in the cable. Loosen the adjusting screw locknut.

3. On later models, the clutch lever at the engine and the crankcase are fitted with marks. Turn the adjusting screw in or out so that the crankcase mark is aligned with the centerline of the clutch lever, as illustrated. Then tighten the adjusting screw locknut, and set the cable to the proper free-play.

4. On earlier models, turn the adjusting screw counterclockwise until resistance is felt; stop, and turn the adjusting

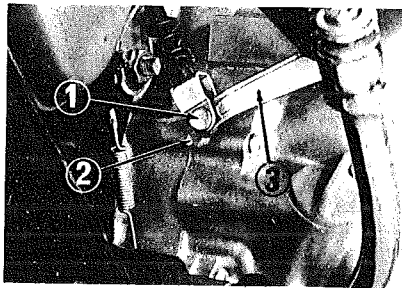

On late model 100–125 cc (to 1975), use the adjuster to align the centerline of the clutch lever (1) with the crankcase mark (2)

screw $\frac{1}{8}$ – $\frac{1}{4}$ turn clockwise, and tighten the locknut. Set the cable free-play to the proper specification.

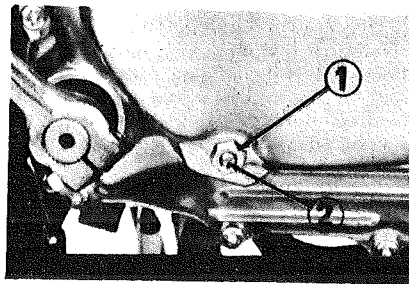

Clutch adjuster location (100–125 cc) (1975 and earlier)

5. Check clutch operation with the forks turned fully to one side or the other. Be sure that the cable is not kinked or sharply bent anywhere along its route.

Throttle Cable

The throttle cable should be adjusted after the idle speed. This procedure is given in the “Tune-Up” section.

The throttle cable should have enough free-play to allow 10–15° of twist-grip rotation before the throttle slide begins to lift.

1. The throttle cable can be adjusted with either the adjuster near the twist-grip, or the adjuster located on the top of the carburetor, beneath the rubber boot. Most have adjusters in both these locations. It is preferable to turn each adjuster out a little way, rather than have one turned out to near its limit.

Front Brake (Drum)

1. Use the adjuster nut at the lower end of the cable or the cable adjuster on the brake plate (depending on model) to allow the handlebar lever to move 20–30 mm (0.8–1.2 in.) before the linings contact the drum. This movement is measured at the tip of the lever.

2. Maintain the adjustment as the linings wear by using the cable adjuster at the handlebar lever.

Front Brake (Disc)

1. The handlebar lever should have 20–30 mm (0.8–1.2 in.) of free-play before the pads contact the disc.

2. The brake cable is self-adjusting; if

service is necessary refer to the “Chassis” section.

Rear Brake

1. Use the adjusting nut on the end of the brake rod so that the brake pedal has about 25 mm (1 in.) of travel before the shoes contact the drum.

2. On models which have an auxiliary rear brake lever on the left handlebar, use the brake cable adjuster at the lower end of the cable so that the hand lever will move 20–30 mm (0.8–1.2 in.) before the linings contact the drum.

Note that the two brake adjustments (pedal and lever) are accomplished independently, but adjusting one necessitates adjusting the other.

Brake Wear

1. On disc brakes, the pads are equipped with red wear limit marks; they must be replaced as a set when worn to the red line.

2. Some late models are equipped with brake wear indicator marks on the brake lever and plate. If the marks line up when the brake is fully applied, inspect or replace the brake shoes.

3. When the brake is fully applied, the angle formed by the brake plate lever and the cable or rod should not be greater than 90°. If it is, and brake adjustment is correct, it is probable that the linings are worn to the point of replacement.

Brake Light Switch

The switch should be checked for operation after the brakes are adjusted. The rear brake light switch is adjustable and is mounted in a slotted bracket and secured by locknuts. Moving the switch up on the bracket allows the brake light to turn on sooner. Moving it down allows the light to turn on later. Generally, the brake light should come on just as the linings contact the drum.

Steering Stem Bearings

The steering stem bearings should be checked periodically and adjusted if necessary. Refer to the “Chassis” section.

Grasp the fork sliders (with the front wheel supported off the ground) and pull them straight out. No play should be felt. If play is evident or if the bearings bind or make noise when the forks are turned, adjustment and lubrication are needed.

FUEL SYSTEM

1. Fuel system maintenance involves cleaning the petcock and filter, cleaning or replacing the air cleaner, and cleaning the carburetor.

2. The carburetor should be removed, disassembled, and cleaned every 3,000 miles. The procedures are outlined in the “Fuel Systems” section.

3. The petcock should be serviced every 3,000 miles. On models with a sediment bowl or a carburetor-mounted petcock, shut off the fuel, unscrew the sediment bowl or cover plate and take out the O-ring and filter screen. Clean the parts in solvent and inspect the screen for

Honda 4-Stroke Singles

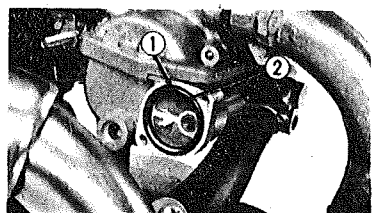

On some models, the O-ring and screen (1 and 2) are located in the carburetor itself

holes or other defects; replace it with a new one if damaged in any way. Inspect the O-ring for any cuts or cracks and replace it if necessary. After installing the parts, turn on the fuel and check for leaks.

Some models require that the petcock be removed to clean the filter screen. In this case, drain the gas tank, disconnect the fuel lines, and unscrew and remove the petcock. Clean the filter. Check the condition of the rubber petcock washer. After installation, check for leaks.

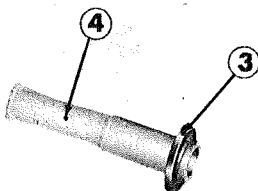
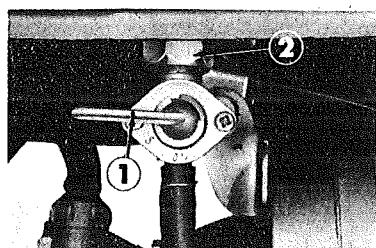

Petcock (1), securing nut (2); the O-ring and filter screen (3 and 4) are located on the petcock intake pipe

Air Cleaner Service

1. Newer models are equipped with a foam-type filter element. After removing the element, wash it in solvent (such as kerosene) and wring dry. Then soak the element in SAE 10W-30 oil and wring off the excess. Reinstall.

Filter maintenance should be carried out at least every 1,500 miles, or 30 operating days, but more often if the machine is operated in dusty areas.

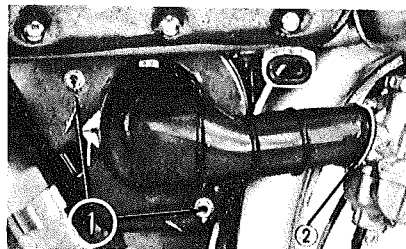

Air cleaner securing nuts (1), and spring clamp (2) (100-125 cc)

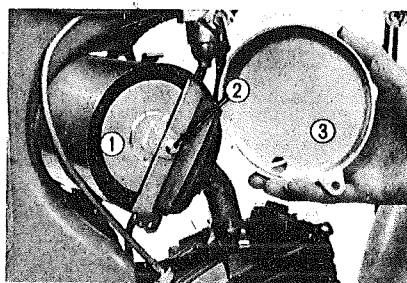

Air cleaner element (1), securing bolt (2), and cover plate (3) (90 cc)

2. Older models have a paper element. The filter element is serviced by brushing off the outside with a stiff brush to loosen any accumulated dirt. Then apply compressed air through the inside of the filter to remove the deposits.

Note that this method is only partially effective. It is recommended that the element be replaced after two or three such cleaning operations. Replacing the paper element with the newer foam-type if possible is recommended.

DECARBONIZATION

1. Models equipped with spark arrestors should have this item serviced every 1,500 miles or every 30 operating days. Excessive carbon buildup in the spark arrestor will cause sluggish performance and possible engine overheating.

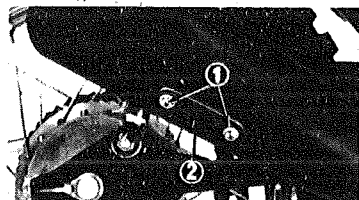

Spark arrestor cover plate (2) and securing screws (1) (XR75 shown)

2. Models may be equipped with a simple spark arrestor cover plate, or a removable baffle at the end of the muffler, or both, depending on the type of exhaust system fitted (see the illustrations).

3. Spark arrestor maintenance should be done when the engine is cold.

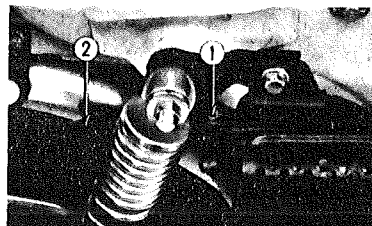

Spark arrestor (2) and securing bolt (1) (ST90 shown)

4. On models with only a spark arrestor cover plate, remove the cover screws and the cover. Start the engine, allow it to

warm up, and rev it about 20 times to clean out the arrestor port. Check the condition of the cover plate gasket, and fit a new one if damaged.

5. On models with a removable baffle, remove the securing bolt at the end of the exhaust pipe. Grasp the spark arrestor with large pliers and pull it out.

Heat the spark arrestor with a propane torch until it is quite hot. Grasping the arrestor with large pliers, tap it against a wooden block to knock off carbon particles. When it cools, remove the rest of the deposits with a stiff wire brush and solvent.

Before replacing the arrestor, start the engine and rev it several times to remove any carbon built up in the muffler.

6. On models with both a cover plate and a removable arrestor, perform both Steps (4 and 5).

NOTE: These procedures must be carried out out-doors in an area away from combustible materials.

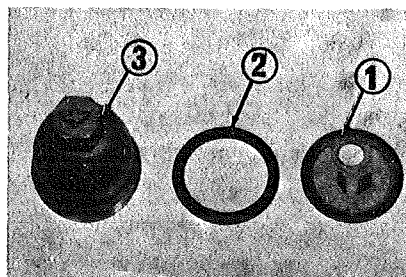

Petcock components: (1) filter screen; (2) O-ring; (3) sediment bowl

HEADLIGHT ADJUSTMENT

Set the machine about 25 feet away from and perpendicular to a wall, preferably of a color which reflects light well.

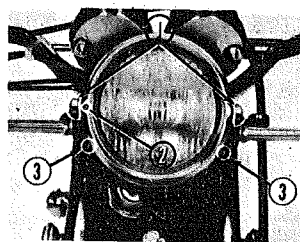

Headlight mounting bolts (1), lateral adjusting screw (2), and rim mounting screws (3)

The machine should be off the stand, and with a rider putting his weight on the machine as in operation. Start the engine and switch on the high beam. The headlight high beam should be parallel to the ground, and should hit the wall directly in front of the machine.

Vertical adjustment is made by loosening the two headlight mounting bolts slightly and pivoting the headlight up or down.

Lateral adjustment is made by means of the screw on the right-side of the headlight. Turning the screw clockwise will move the beam to the left and vice versa.

Honda 4-Stroke Singles

Maintenance Data

50, 65, 70 cc Engines

Recommended Lubricants	
Engine	
High-detergent motor oil, service rated "SE"	
All temperatures: SAE 10W-40 SAE 10W-30	
Above 59° F	SAE 20-50 SAE 30
32-59° F	SAE 20/20W
Below 32° F	SAE 10W
Front Forks	
ATF	
SAE 10W-40	
SAE 30	
SAE 20	
Air Filter (foam type)	
SAE 10W-30	
Wheel and Steering Head Bearings	
High-quality bearing grease	
Grease Fittings	
High-quality chassis grease	
Cables and General Lubrication	
Molybdenum disulfide or graphite-based lubricants	
SAE 20 or 30 oil	
Drive Chain	
Lubricant designed specifically for motorcycle drive chains	

	Gas Tank (gal)	Engine Oil (qt/l)	Front Forks @ Leg (oz/cc)	Tire Pressure ^① Front/Rear (psi)
Z50A	1.0	0.8/0.8	—	14/14
C65/M	1.2	0.8/0.8	—	24/30
S65	1.7	0.8/0.8	—	24/30
C70/M	1.2	0.7/0.7	—	25/28
CL70	1.6	0.7/0.7	3.4/100	25/28
CT70, K1	0.66	0.7/0.7	—	18/21
CT70K2-on	0.65	0.7/0.7	3.4/100	17/20
CT70H, K1	0.66	0.7/0.7	—	18/21
CT70H K2-on	0.66	0.7/0.7	3.4/100	18/21
SL70	1.3	0.7/0.7	3.7/110	20/23
XR75	0.8	0.9/0.9	3.7/110	17/20

90 cc Engines

S90	1.8	0.9/0.9	4.4-4.7/130-140	26/29
CL90/L	2.0	0.9/0.9	4.4-4.7/130-140	26/29
CD90	1.8	0.9/0.9	—	26/29
C90	1.5	0.9/0.9	—	26/29
CT90	1.7	0.9/0.9	—	26/29
CT90 from Frame No. 000001A-on	1.6	0.9/0.9	4.4-4.7/130-140	26/28
SL90	2.2	0.9/0.9	6.1-6.5/180-190	26/29
ST90	0.7	1.0/1.0	3.6-3.7/105-110	18/24

100, 125 cc Engines

CB100, K1-K2	2.0	1.1/1.0	4.4-4.7/130-140	26/29
CB100K3	2.0	1.1/1.0	3.6-3.7/105-110	26/32
CL100/S	2.0	1.1/1.0	4.4-4.7/130-140	26/28
SL100	2.0	1.1/1.0	6.1-6.5/180-190	26/28
SL100 K2-on	1.8	1.1/1.0	4.6-4.9/135-145	26/28
CB125S, CD125S	2.0	1.1/1.0	4.4-4.7/130-140	26/28
CB125S1/S2	2.0	1.1/1.0	4.1-4.4/120-130	26/28
CB125 (76)	2.5	1.1/1.0	3.6-3.7/105-110	26/32
CL125S	2.0	1.1/1.0	4.1-4.4/120-130	26/28
SL125, K1	1.8	1.1/1.0	6.1-6.5/180-190	26/28
SL125 K2-on	1.8	1.1/1.0	4.9-5.3/145-155	26/28
TL125	1.2	1.1/1.0	4.4-4.7/130-140	7-21

Periodic Maintenance *

Weekly
Check engine oil level
Tire pressure (cold)
Spokes for tightness
Battery electrolyte level
Tightness of critical nuts and bolts
Chain adjustment
Every 200 miles
Lubricate and adjust drive chain
Every 1500 miles
Change engine oil
Clean and inspect air filter element
Decarbonize spark arrestor
Every 2000 miles
Clean and lubricate drive chain
Every 3000 miles
Clean and gap spark plug
Check points and ignition timing
Check valve adjustment
Check cam chain tension
Check clutch
Check carburetor settings
Clean fuel filter and sediment bowl
Grease fittings
Lubricate controls and cables
Every 6000 miles
Clean centrifugal and screen oil filters
Change front fork oil
Adjust steering head bearings

* Mileage based upon normal usage after break-in is complete

① Add 2 psi front, 4-6 psi rear, when carrying a passenger or for high-speed operation
— Not applicable

Honda 4-Stroke Singles

Battery Specifications

Model	Yuasa Battery	Voltage	Amp Hrs	Continuous Charging Rate (amps)
Z50A K1	B60-6	6	2	0.2
S65, C65	MBC1-6A	6	2	0.2
C70M	6N11-2D	6	11	1.1
CL70	6N5.5-1D-1	6	5.5	0.5
CT70/H	B60-6A	6	2	0.2
CT70 K1 CT70H K1	B60-6	6	2	0.2
SL70	B60-6A	6	2	0.2
SL70 K1	B60-6	6	2	0.2
CT90	B37-6A	6	5.5	0.5
S90	6N6-1B	6	6	0.6
CL90	6N6-1B	6	6	0.6
SL90	B37-6A	6	5.5	0.5
ST90	B37-6A	6	5.5	0.5
CB/CL/SL100	6N6-3B	6	6	0.6
CD/CB/CL/SL125 (All)	6N6-3B	6	6	0.6

TUNE-UP

NOTE: Common tune-up procedures are explained in detail in "General Information."

CAM CHAIN ADJUSTMENT

NOTE: Early models under 100 cc had an automatically tensioned cam chain. No adjustment is necessary. For other models, refer to the appropriate heading below.

100/125 cc Engines

1975 AND EARLIER

1. The cam chain adjuster and locknut are located on the top of the crankcase behind and to the left of the cylinder, beneath a rubber cap.

2. With the engine idling, note the indication of chain noise. Chattering will indicate that the chain is too loose; whining means that it is too tight.

3. With the engine idling, loosen the adjuster locknut. Turn the adjuster clockwise about half a turn so that it is loose; then turn it counterclockwise to take up slack in a loose chain.

4. Turn the adjuster until resistance is felt. The chain should be operating quietly at this point. It should not be

necessary to turn the adjuster very much to achieve adjustment.

5. Tighten the adjuster locknut.

6. If the adjuster was turned too far, the chain will be too tight and will begin to whine. In this case, repeat the adjustment procedure until quiet operation is obtained.

(1976 AND LATER)

1. The cam chain adjuster is located behind and to the left of the cylinder, beneath a rubber cap.

2. With the engine idling, loosen the large adjusting bolt, then retighten. Tension will be set automatically.

NOTE: A 6 x 10 mm bolt is fitted to the top of the adjusting bolt. Do not loosen this bolt.

50-90 cc Engines (Except XR75)

Some early models such as the Z50-K2 have an automatic tensioner; no adjust-

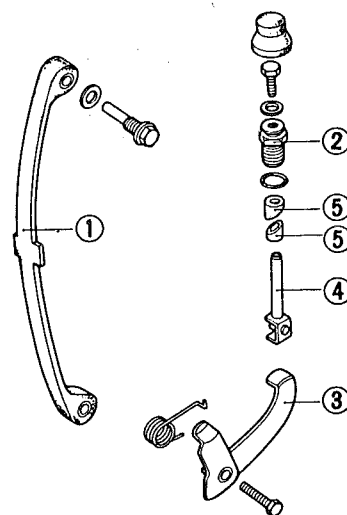

Cam chain adjuster (100-125, 76)

1. Cam chain tensioner
2. Adjusting bolt
3. Tensioner arm
4. Set bar
5. Collars

ment is necessary. For other models, proceed as follows:

1. Cam chain adjustment is made with the engine idling. The adjustments can be made in two ways: either with the adjusting screw or with the tensioner bolt.

The adjusting screw locks the spring-loaded tensioner rod in place, and loosening it will allow tension to be automatically taken up.

The tensioner bolt allows the tensioner rod to be moved, compressing the tensioner itself.

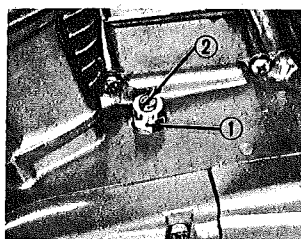

Cam chain adjuster (2) and locknut (1) (100-125, to 1975)

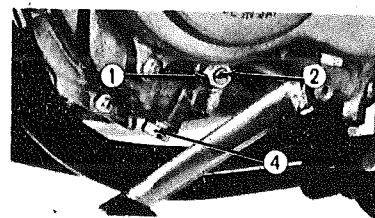

Locknut (1), adjusting screw (2), and tensioner cover bolt (4) (50-70 cc)

The adjusting screw is located at the bottom of the left crankcase cover. The tensioner bolt is just below the adjusting screw, beneath a cover bolt.

2. With the engine idling, loosen the adjusting screw locknut and back the screw off (counterclockwise) about 1/2 turn. Tighten the adjusting screw. If chain operation is now quiet, tighten the adjusting screw locknut, since the adjustment is now complete. If chain operation is still noisy, proceed as follows:

3. Remove the tensioner cover bolt. Loosen the adjusting screw locknut and back off the adjusting screw about 1/2 turn.

4. Turn the tensioner bolt in or out slowly until proper chain operation is obtained. If the chain chatters, it is too loose and the tensioner bolt should be turned clockwise; if the chain whines, it is too

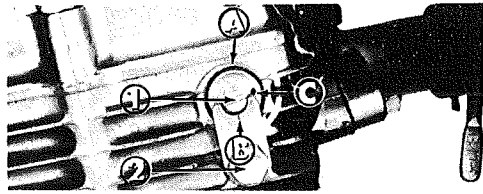

Cam chain adjuster plate bolt (2), chain adjuster (1); median position (C) (XR75)

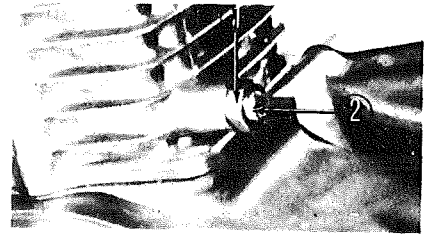

Cam chain tensioner (2) and locknut (1) (XR75)

tight, and the tensioner bolt should be turned counterclockwise.

5. When chain operation is quiet, replace the cover bolt, tighten the adjusting screw and the adjusting screw locknut. Adjustment is now complete.

XR75

1. Adjust the cam chain if operation is noisy. The adjuster is located at the top left-side of the cylinder head.

2. Adjust the cam chain with the engine idling. Loosen the chain adjuster plate bolt. If the chain chatters, turn the adjuster clockwise to take up excess slack. If the chain whines, turn the adjuster counterclockwise to increase slack.

NOTE: Do not attempt to turn the adjuster more than 90° from the median position.

3. When chain operation is quiet, tighten the plate bolt.

4. If turning the adjuster fully to position "B" in the illustration fails to quiet a loose chain, proceed as follows:

5. Shut off the engine. Remove the magneto cover, spark plug, and head cover. Turn the engine over (counterclockwise) until the intake valve goes down and comes up. Continue turning the engine over until the "T" mark on the rotor is aligned with the index mark on the crankcase cover. The piston is now at top dead center on the compression stroke.

6. The cam chain tensioner is located at the bottom rear of the cylinder.

Loosen the adjuster plate bolt, and turn the adjuster so that the punch mark lines up with position "C" as shown in the illustration. This is the middle of the adjustment range.

7. Holding the piston at TDC, loosen the tensioner locknut. Back the tensioner off about 1/2 turn, then tighten it. Secure the locknut.

8. Start the engine and make any adjustment to the cam chain necessary using the adjuster on the head as before.

4. Remove the spark plug.

5. Turn the engine over slowly in the normal direction of rotation (the rotor will turn counterclockwise) while observing the intake valve. When the valve goes down and begins to come up, continue turning the engine over until the "T" mark on the rotor lines up with the timing index mark on the crankcase cover.

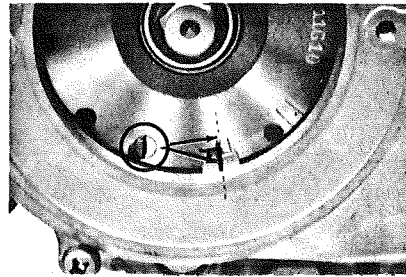

Piston top dead center occurs when the "T" mark on the rotor aligns with the index mark on the crankcase cover (1) (100-125 cc shown)

6. The piston should now be at top dead center on the compression stroke with both valves closed. Check for clearance at the valves. Each should have a slight amount of free-play. If they do not, the piston is at TDC on the exhaust stroke. Turn the rotor 360° and check again.

7. Valve clearance for all models is 0.002 in. (0.05 mm) for both intake and exhaust valves.

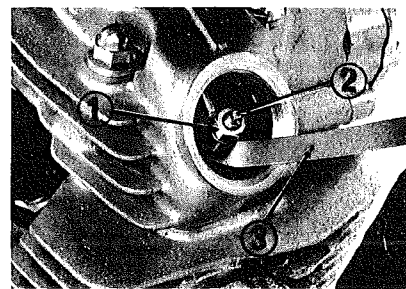

Adjusting the valve clearance: loosen the adjuster locknut (1) and turn the adjuster (2) until the feeler gauge (3) is a slip fit between the adjuster and the valve

8. If adjustment is necessary, loosen the adjuster locknut and turn the adjuster to effect proper adjustment. Tighten the locknut.

NOTE: The adjustment may change when the locknut is tightened. Hold the adjuster steady while securing the nut. Recheck the clearance afterward.

9. Repeat the procedure at the other valve.

CONTACT BREAKER POINTS

Location

1. On battery ignition 90, 100, and 125 cc machines and the magneto-ignition TL125, the points are located in a case on the left-side of the cylinder head, and are operated off the camshaft. The timing advance mechanism is fitted behind the breaker point plate.

2. On 50-70 cc machines, the points are fitted to the stator plate beneath the magneto rotor. The timing advance mechanism is fitted to the rotor, on those models which have one.

Replacement

1. If replacement of the points is necessary, this is easily accomplished on all 90-125 cc bikes by disconnecting the primary wire, removing the two point securing screws and taking off the points. Install the new points after thoroughly cleaning off the contact surfaces with a non-oily solvent, and adjust the gap.

2. On 50-70 cc machines, remove the left crankcase cover. Use the special pulley to remove the magneto rotor after removing the rotor nut. Disconnect the primary wire, remove the points securing screw. Install the new point set and reset the gap. Check the ignition timing.

CAUTION: Ensure that all insulating washers are correctly installed. Check that there is no continuity between the primary wire and the engine when the points are open, and that there is continuity when they are closed.

3. Apply a bit of grease to the breaker cam lubricating wick. Take care not to apply too much to avoid fouling the points.

Gapping

Gapping is necessary to compensate for wear of the contact surfaces due to electrical arcing and for wear of the breaker point fiber heel. As the heel wears the points will open later relative to the rotation of the crankshaft, retarding the timing.

Points should be filed (if necessary) and cleaned before gapping.

NOTE: On 50-70 cc machines the ignition timing is adjusted by changing the point gap. Therefore these operations must be carried out at the same time.

VALVE ADJUSTMENT

All Models

NOTE: Valves must be adjusted when the engine is cold.

1. Remove the alternator or magneto rotor cover or inspection cap.

2. 100/125 and XR75: Remove the gas tank.

3. Remove the intake and exhaust valve caps, or the head cover on the XR75.

Honda 4-Stroke Singles

Tune-Up Specifications

	Z50A	C65/M	S65
IGNITION			
Standard spark plug (NGK)	C6H	C7HS	C7HS
Spark plug gap (in./mm)	0.024-0.028/0.6-0.7	0.024-0.028/0.6-0.7	0.024-0.028/0.6-0.7
Breaker point gap (in./mm)	0.012-0.016/0.3-0.4	0.012-0.016/0.3-0.4	0.012-0.016/0.3-0.4
VALVE CLEARANCE			
Intake (in./mm)	0.002/0.05	0.002/0.05	0.002/0.05
Exhaust (in./mm)	0.002/0.05	0.002/0.05	0.002/0.05
CARBURETOR			
Pilot air screw (turns out)	1½	1¼	1½
Float level (in./mm)	0.7/18Ⓞ	0.69/17.5	0.8/19.5
Idle speed (rpm)	1400	1000-1200	1000-1200
CRANKING COMPRESSION (psi)	170	170	170

	C70	C70M	CL70
IGNITION			
Standard spark plug (NGK)	C7HS	C7HS	C7HS
Spark plug gap (in./mm)	0.024-0.028/0.6-0.7	0.024-0.028/0.6-0.7	0.024-0.028/0.6-0.7
Breaker point gap (in./mm)	0.012-0.016/0.3-0.4	0.012-0.016/0.3-0.4	0.012-0.016/0.3-0.4
VALVE CLEARANCE			
Intake (in./mm)	0.002/0.05	0.002/0.05	0.002/0.05
Exhaust (in./mm)	0.002/0.05	0.002/0.05	0.002/0.05
CARBURETOR			
Pilot air screw (turns out)	1½	1¾	1¾
Float level (in./mm)	0.60/15.5	0.60/15.5	0.3/7.0
Idle speed (rpm)	1200	1200	1300
CRANKING COMPRESSION (psi)	170	170	170

	CT70/H	SL70	XR75
IGNITION			
Standard spark plug (NGK)	C7HS	C7HS	C7HS
Spark plug gap (in./mm)	0.024-0.028/0.6-0.7	0.024-0.028/0.6-0.7	0.024-0.028/0.6-0.7
Breaker point gap (in./mm)	0.012-0.016/0.3-0.4	0.012-0.016/0.3-0.4	0.012-0.016/0.3-0.4
VALVE CLEARANCE			
Intake (in./mm)	0.002/0.05	0.002/0.05	0.002/0.05
Exhaust (in./mm)	0.002/0.05	0.002/0.05	0.002/0.05

90-125 CC

1. Remove the points cover.
2. Turn the engine over slowly until the points are open to their maximum gap.
3. With the proper feeler gauge, check the gap. The proper specification for all models is 0.012-0.016 in. (0.3-0.4 mm).

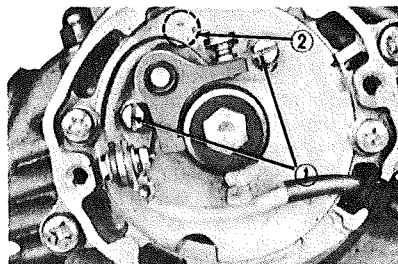

To adjust the point gap, loosen the two screws (1), and lever the points with a screwdriver at (2) (90-125 cc)

4. If adjustment is necessary, loosen the two screws which secure the points to the base plate, and use a thin screwdriver at the pry slot provided to bring the gap to the proper specification.

NOTE: Loosen the screws just enough to allow the points to be moved. If too loose, the points will snap shut instead of holding the adjustment.

5. Tighten the screws and recheck the gap. It may change slightly when the screws are tightened.
6. If it is not possible to gap the points correctly, the fiber heel is evidently worn, and the point set should be replaced.

50-70CC

1. On these models, adjusting the point gap is the only method of adjusting the ignition timing, so the timing should be checked whenever the points are gapped.

2. Remove the rotor cover.
3. Turn the engine over, observing the points through the cutout in the rotor until they are opened to their maximum gap.

4. With the proper feeler gauge blade, check the gap. Proper gap for all models is 0.012-0.016 in. (0.3-0.4 mm).

5. If adjustment is necessary, loosen the point securing screw, and use a thin screwdriver at the pry slot provided to bring the gap to within the proper specification.

NOTE: Loosen the securing screw just enough to allow the gap to be adjusted.

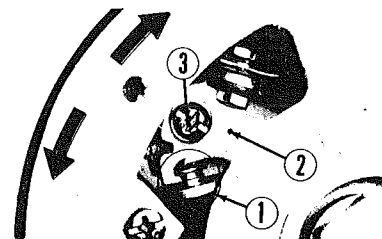

The point securing screw (3) is loosened slightly to change the point gap on most 50-70 cc models

Honda 4-Stroke Singles

Tune-Up Specifications (cont.)

	CT70/H	SL70	XR75
CARBURETOR			
Pilot air screw (turns out)	1¼	1½	1¼
Float level (in./mm)	0.78/20.0	0.28/7.0	0.83/21.0
Idle speed (rpm)	1300	1500	1400
CRANKING COMPRESSION (psi)	170	170	170
	S90	CL90/L	CD90
IGNITION			
Standard spark plug (NGK)	D6HS	D6HS	D6HS
Spark plug gap (in./mm)	0.024-0.028/0.6-0.7	0.024-0.028/0.6-0.7	0.024-0.028/0.6-0.7
Breaker point gap (in./mm)	0.012-0.016/0.3-0.4	0.012-0.016/0.3-0.4	0.012-0.016/0.3-0.4
VALVE CLEARANCE			
Intake (in./mm)	0.002/0.05	0.002/0.05	0.002/0.05
Exhaust (in./mm)	0.002/0.05	0.002/0.05	0.002/0.05
CARBURETOR			
Pilot air screw (turns out)	1¼	1½	1¼
Float level (in./mm)	②	0.78/19.5	0.83/21.0
Idle speed (rpm)	1250-1350	1250-1350	1250-1350
CRANKING COMPRESSION (psi)	170	170	170
	C90	CT90	CT90 (from Frame No. 000001A)
IGNITION			
Standard spark plug (NGK)	D6HS	D8HS	D8HS
Spark plug gap (in./mm)	0.024-0.028/0.6-0.7	0.024-0.028/0.6-0.7	0.024-0.028/0.6-0.7
Breaker point gap (in./mm)	0.012-0.016/0.3-0.4	0.012-0.016/0.3-0.4	0.012-0.016/0.3-0.4
VALVE CLEARANCE			
Intake (in./mm)	0.002/0.05	0.002/0.05	0.002/0.05
Exhaust (in./mm)	0.002/0.05	0.002/0.05	0.002/0.05
CARBURETOR			
Pilot air screw (turns out)	1	1½	1¼
Float level (in./mm)	0.83/21.0	0.83/21.0	③
Idle speed (rpm)	1400-1600	1400-1600	1400-1600
CRANKING COMPRESSION (psi)	170	170	170

② Keihin—0.78/19.5
Mikuni—0.95/24.0

③ CT90—0.85/21.5
K1—0.94/23.5

If it is too loose the points will close completely instead of holding the adjustment.

6. Tighten the screw and recheck the gap. It may change slightly when the screw is tightened.

7. If it is not possible to correctly gap the points, the fiber heel is evidently badly worn and the point set should be replaced.

IGNITION TIMING

Dynamic Timing

ALL MODELS

1. Remove the magneto or alternator rotor cover so that the timing marks are visible.

2. Hook up the timing light according to the manufacturer's instructions. Most lights use the vehicle's own battery as a power source.

3. Start the engine, aiming the light on the rotor. Note the following:

a. At idle, the "F" mark on the rotor should line up with the timing indicator on the crankcase cover;

b. As the revolutions increase, the "F" mark should be seen to move in a direction opposite that of crankshaft rotation (except on Z50 and CT70 models which do not have timing advance mechanisms);

c. Finally, at full advance (about 3,000 rpm and above on most models), the twin rotor marks must line up with the timing indicator mark on the crankcase cover.

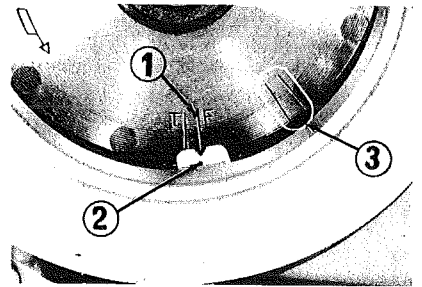

The "F" mark (1) is the firing point with the timing not advanced. The two slash marks (3) indicate the full advance firing point. (2) is the stationary timing mark.

4. The full advance reading is the most important. If the rotor and crankcase marks do not align, proceed as follows:

5. 90-125 cc models: remove the points cover. Loosen the two screws which secure the breaker base plate just enough to allow the plate to be turned. Using a thin screwdriver applied at the pry point provided, rotate the plate in the direction necessary so that the timing marks align.

Rotating the plate clockwise advances the timing; rotating it counterclockwise retards the timing.

Tighten the breaker plate screws and recheck the timing.

6. 50-70 cc models: Timing is adjusted by changing the point gap. Set the point

Honda 4-Stroke Singles

Tune-Up Specifications (cont.)

	CT90 (K2-on)	SL90	ST90
IGNITION			
Standard spark plug (NGK)	D8HS	D8HS	D6HS
Spark plug gap (in./mm)	0.024-0.028/0.6-0.7	0.024-0.028/0.6-0.7	0.024-0.028/0.6-0.7
Breaker point gap (in./mm)	0.012-0.016/0.3-0.4	0.012-0.016/0.3-0.4	0.012-0.016/0.3-0.4
VALVE CLEARANCE			
Intake (in./mm)	0.002/0.05	0.002/0.05	0.002/0.05
Exhaust (in./mm)	0.002/0.05	0.002/0.05	0.002/0.05
CARBURETOR			
Pilot air screw (turns out)	1	1¼	1½
Float level (in./mm)	0.78/20.0	0.2/5.0	0.83/21.0
Idle speed (rpm)	1300	1300	1200-1300
CRANKING COMPRESSION (psi)	170	170	170

IGNITION

	CD/CB/CL/ SL-100/125	TL125(To 75)	TL 125 (70)
Standard spark plug (NGK)	D8ESL	D8ESL	D8ESL
Spark plug gap (in./mm)	0.024-0.028/0.6-0.7	0.024-0.028/0.6-0.7	0.024-0.028/0.6-0.7
Breaker point gap (in./mm)	0.012-0.016/0.3-0.4	0.012-0.016/0.3-0.4	0.012-0.016/0.3-0.4

VALVE CLEARANCE

Intake (in./mm)	0.002/0.05	0.002/0.05	0.002/0.05
Exhaust (in./mm)	0.002/0.05	0.002/0.05	0.002/0.05

CARBURETOR

Pilot air screw (turns out)	1½	¾-1	1
Float level (in./mm)	0.95/24.0	0.85/21.5	0.95/24.0
Idle speed (rpm)	1200-1300	1300	1300
CRANKING COMPRESSION (psi)	170	170	170

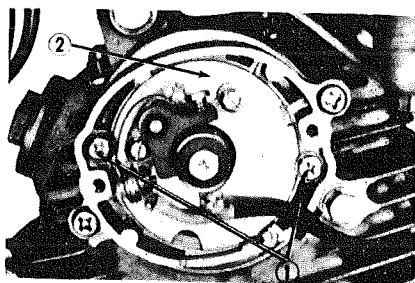

To adjust the ignition timing, loosen the two screws (1), and rotate the base plate (2) (90-125 cc)

gap to the proper value (0.012-0.016 in./0.3-0.4 mm) as previously outlined. If

the strobe light indicates that the timing is not incorrect, increase or decrease the point gap until it is.

NOTE: Increasing the point gap advances the timing; decreasing it retards the timing. The point gap must still remain within the limits given. If it is not possible to correct the timing while retaining the proper gap, the points must be replaced.

Static Timing

90-125 CC MODELS

1. Remove the alternator rotor cover and the points cover. Remove the spark plug and intake valve cover.

2. Hook the tester up. Remember that if a light is used on the magneto ignition TL125, the black/white points wire must be disconnected.

3. Turn the engine over so that the engine is just beginning its compression stroke. (The intake valve will go down and come up). Turn the rotor slowly in the normal direction of rotation (counterclockwise). At the instant in which the "F" mark on the rotor aligns with the mark on the crankcase cover, the points should begin to open as indicated by the reaction of the test light or the meter.

4. If the points open before the marks align, the timing is too advanced. If they open after the "F" mark passes the stationary mark, the timing is too retarded.

5. If the timing is not correct, loosen the two phillips screws which secure the breaker base plate to the engine. Loosen them just enough to allow the plate to be rotated.

6. Turn the plate using a thin screwdriver applied to the pry slot provided so that the points open just as the "F" mark lines up with the stationary mark. If the timing was too advanced, turn the plate counterclockwise. If too retarded, rotate the plate clockwise.

7. Tighten the breaker plate screws and recheck the timing. Sometimes this will cause the plate to move slightly and throw the timing off.

50-70CC MODELS

The timing on these models is accomplished by changing the point gap.

1. Remove the spark plug and the magneto rotor cover.

2. Clean and gap the points to the proper specification as outlined under "Gapping."

3. Hook up the ohmmeter to ground and to the black wire coming from the points.

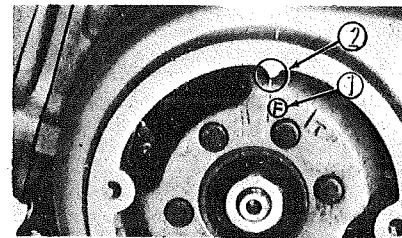

The points should just begin to open when the "F" mark on the rotor aligns with the stationary timing mark (50-70 cc)

4. Turn the rotor slowly in the normal direction of rotation (counterclockwise). When the "F" mark on the rotor and the stationary timing mark on the crankcase align, the meter should indicate that the points have just begun to open.

5. If the points open after the "F" mark passes the stationary mark, the timing is too retarded; if they open before the "F" mark aligns, the timing is too advanced.

6. As noted above, ignition timing is corrected by changing the point gap. If the timing was retarded, increase the point gap. If it was advanced, decrease the point gap.

NOTE: It should be possible to set the timing perfectly while maintaining the point gap within the specification given (0.012–0.016 in. 0.3–0.4 mm). If the timing marks will not align when the point gap is within this specification, the points must be replaced. Wear of the fiber heel is one cause of this condition.

CARBURETOR

Adjusting Float Level

Generally, float level will not need adjustment unless the carburetor has been disassembled, fuel delivery problems have been noted, or considerable mileage has been covered.

1. Remove the carburetor from the motorcycle as outlined in the "Fuel Systems" section.

2. Remove the float bowl. Remove the float bowl gasket.

3. Float level is defined as the measured distance from the float bowl mating surface on the carburetor body (gasket removed) to the top of the floats, when the tang of the float arm is just touching the end of the float needle. A special gauge is available to check the float level although a vernier caliper can also be used.

4. With the carburetor upside down, gradually lower the floats until the tang of the float arm just touches the end of the float needle. The tang should not depress the needle, but just contact it. Measure

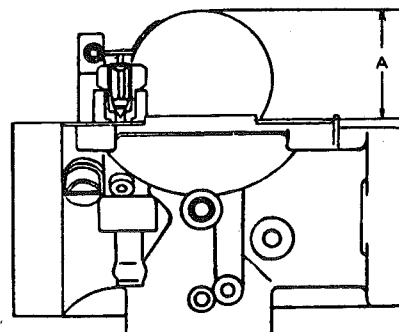

Float level is the distance "A" from the float bowl gasket surface (gasket removed) to the top of the floats

the distance from the carburetor body to the top of the floats. Compare the reading with the proper float level for your machine as given in the "Tune-Up Specifications" chart at the end of this section.

5. If adjustment is necessary, bend the float arm tang *only* to raise or lower the float level.

6. Float level will not be correct if the needle is worn, or if there is foreign matter on the needle seat. Refer to "Carburetor" for more information.

Idle Speed and Mixture

NOTE: These items must be adjusted when the engine is at operating temperature.

1. Ensure that the throttle cable adjustment is approximately correct so that the cable has enough slack to allow the throttle slide to be fully closed.

2. Screw the pilot air screw in (carefully) until it bottoms lightly, then turn it out the number of turns shown in the "Tune-Up Specifications" chart at the end of this section.

3. Start the engine. When operating temperature is reached, adjust the throttle stop screw so that the engine idles as slowly as possible. Then turn the pilot air screw in or out until the engine runs smoothly. It should not be necessary to vary the air screw more than one half turn in either direction from the given setting.

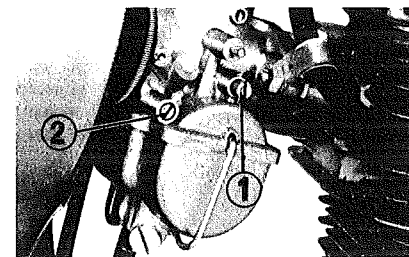

Throttle stop (1) and pilot air (2) screws

4. Adjust the throttle stop screw so that the engine idles at the desired rpm.

NOTE: If proper idling cannot be obtained using this method, it may be that the fuel system is clogged with dirt (check petcock, filter, carburetor), the plug is bad or too cold, the valves are improperly adjusted, or there is an air leak somewhere in the system.

5. After adjusting the idle speed and mixture, adjust the throttle cable as outlined in the "Maintenance" section.

ENGINE AND TRANSMISSION

Removal and installation procedures are given below. Specifications are in the charts at the end of this section. For service procedures of common engine components such as cylinder head, pistons, clutch, etc., refer to the "Engine Rebuilding" section in "General Information."

ENGINE REMOVAL AND INSTALLATION

The following notes apply to all models:

1. Drain the oil before removing the engine.

2. Degreasing and thoroughly cleaning the engine before removal is highly recommended. Be especially attentive to the cylinder base and the underside of the crankcase, and around mating surfaces.

3. On models which have the fuel petcock incorporated into the carburetor, use a C-clamp to pinch off the fuel line before removing the carburetor from the cylinder head.

4. When disconnecting the final drive chain, use pliers to remove the masterlink spring clip. Do not pry the clip off with a screwdriver or it will be distorted and then must be replaced.

After disconnecting the chain, install the masterlink on one end of the chain to prevent loss.

NOTE: On models with a full coverage chaincase, wire the ends of the chain together and attach them to a point on the frame so that the chain doesn't fall into the chaincase.

5. Upon installation, install the spring clip with the closed end facing the direction of chain rotation.

100/125 cc Models

1. Remove the exhaust pipe and muffler. Remove the seat and the gas tank.

2. Remove the rider footpegs (except TL125) by removing the step bar bolted to the lower frame members.

3. Run down the clutch cable adjuster(s) and disconnect the cable from the lever on the engine.

4. Unbolt the carburetor from the engine, and hang it well out of the way to avoid possible damage.

5. Remove the left and right frame sidecovers. Disconnect the alternator leads at the plastic connector. Remove the spark plug cap. Loosen the spark plug. Disconnect the ignition primary wire at the connector near the ignition coil.

6. Disconnect the tach cable at the engine (if fitted).

7. Remove the gearshift lever pinch-bolt and carefully pull the shift lever off the splined shaft. Back off the rear brake adjuster.

8. Remove the left rear crankcase cover. Disconnect the chain.

9. Back off the rear brake adjuster nut to allow a good bit of movement in the brake pedal.

10. Remove the front engine mounting nuts and bolts and remove the mounting plates. Remove the top and rear mounting bolts; remove the engine from the frame.

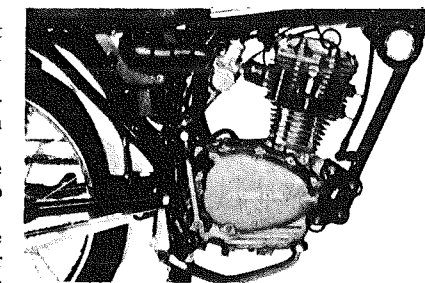

Engine mounting bolt locations

11. Installation is the reverse of the removal procedure. After the engine is fitted into the frame, use a screwdriver

Honda 4-Stroke Singles

through the top mounting bracket to support the engine until the other mounting bolts are fitted.

12. Exhaust system nuts and bolts must be tightened gradually.

ST90

1. Remove the right shock absorber, and remove the muffler along with the rear brackets.

2. Disconnect the spark plug lead and loosen the plug.

3. Unbolt the carburetor from the cylinder head.

4. Remove the rear portion of the left crankcase cover, and disconnect the drive chain.

5. Disconnect the electrical wiring at the plastic connectors. Disengage the carburetor drain tube from the engine clamp.

6. Have an assistant support the motorcycle. The front downtubes (sub-frame) must be removed and the side-stand along with it.

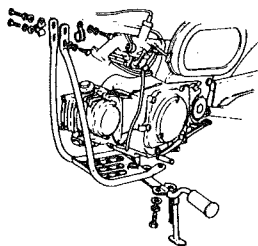

Sub-frame and footpeg assembly (ST90)

7. Remove the footpeg step bar.

8. Remove the sub-frame.

9. Remove the nuts on the rear engine mounting bolts. Support the engine so that it will not fall, and pull out the rear mounting bolts.

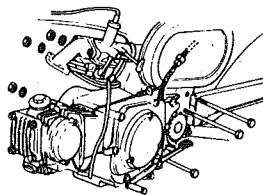

Engine mounting bolts (ST90)

10. Remove the engine from the frame.

11. Before installing the engine, bolt the step bar to it. The remainder of installation is the reverse of removal.

CT90, C90

1. Remove the front fender (CT90) (early models).

2. Remove the frame tube cover (CT90). Remove the fairing (C90).

3. Remove the footpeg step bar.

4. Remove the rear portion of the left crankcase cover and disconnect the drive chain (C90). On the CT90, disconnect the chain and disengage it from the countershaft sprocket.

5. Remove the muffler.

6. Unbolt the carburetor manifold from the cylinder head.

7. Disconnect the electrical wiring at the connectors. Remove the spark plug lead and loosen the spark plug.

8. Disconnect the rear brake pedal return spring.

9. Remove the front downtubes, then remove the top and rear engine mounting bolts, and remove the engine from the frame.

10. Raise the engine into the frame and, have an assistant route the wiring into position.

12. Insert the lower rear mounting bolt through the frame lug and engine from the left-side, then pivot the engine up and install the remaining bolts.

13. The remainder of installation is the reverse of the removal procedure.

SL90

1. Remove the exhaust system.

2. Remove the rear portion of the left crankcase cover, and disconnect the drive chain.

3. Run down the clutch cable adjusters, and disconnect the cable from the engine lever.

4. Remove the spark plug lead and loosen the spark plug.

5. Disconnect the carburetor manifold from the cylinder head.

6. Remove the gearshift and kick-starter lever pinch-bolts, and carefully pull these levers off their shafts.

7. Remove the left sidecover and disconnect the electrical wires at the connectors.

8. Remove the four bolts for the top rear engine mounting plates.

9. Remove the bottom engine mounting bolts and remove the engine from the frame.

10. Installation is the reverse of the removal procedure.

S90, CL90/L, CD90

1. Remove the rider footpeg step bar.

2. Remove the exhaust system.

3. Remove the rear portion of the left crankcase cover and disconnect the drive chain.

4. Run down the cable adjusters and disconnect the clutch cable from the lever at the engine.

5. Disconnect the spark plug lead and loosen the spark plug.

6. Unbolt the carburetor manifold from the cylinder head.

7. Remove the battery cover and disconnect the battery leads. Disconnect the alternator leads at the connector.

8. Unhook the brake pedal spring.

9. Remove the top and rear engine mounting bolts and remove the engine from the frame.

10. Installation is basically the reverse of the removal procedure. Note the following points:

a. Block up the engine under the frame;

b. Route the wiring harness up to the battery box and suspend the engine from the frame by inserting a screwdriver into a frame and engine mounting point;

c. Insert the engine mounting bolts from the left-side, then secure and torque the mounting nuts;

d. Connect the brake pedal return spring to the lower mounting bolt;

e. Connect all the wiring harness leads;

f. Connect the battery leads to the battery terminals, push the wires up into the top of the battery box, install the battery, taking care not to pinch any of the wires, and route the battery overflow tube down through the bottom of the battery box;

g. Connect the clutch cable to the release lever;

h. Install the intake manifold to the cylinder head, taking care to correctly position the O-ring between the manifold and the cylinder head;

i. Attach the high-tension lead to the spark plug. The lead should be secured by the clip under the right-side intake manifold mounting bolt;

j. Install the muffler assembly.

XR75

1. Remove the muffler.

2. Unbolt the carburetor manifold from the cylinder head.

3. Loosen the adjusters on the clutch cable and disconnect the cable from the lever on the engine.

4. Remove the spark plug cap and loosen the spark plug.

5. Remove the left-side crankcase cover. Disconnect the drive chain.

6. Disconnect the magneto wire at the connector.

7. Loosen all of the mounting bolt nuts.

8. Remove the front mounting bolts and mounting plates. While supporting the engine with one hand, remove the upper rear mounting bolt.

9. Let the engine swing forward; then remove the lower rear bolt.

10. Installation is the reverse of removal.

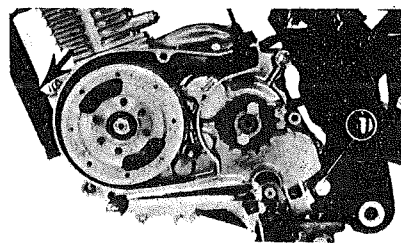

Lower rear engine mounting bolt (XR75)

SL70

1. Remove the seat by loosening the shock absorber capnuts and pulling it off. Disconnect the fuel line at the petcock and fold back the rubber mounting at the rear of the gas tank. Pull the gas tank back and off the machine.

2. Remove the frame sidecovers. Disconnect and remove the battery. Remove the tool box. Remove the chain guard. Remove the gearshift lever and the kick-starter lever.

3. Remove the engine left-side cover. Use an impact driver to loosen the Phillips screws to avoid damage.

4. Disconnect the drive chain.

5. Remove the exhaust system after

unbolting the muffler from the frame and the exhaust pipe from the cylinder head.

6. Loosen the carburetor air cleaner hose clamp screw, remove the air cleaner case mounting bolts, and remove the case.

7. Unscrew the carburetor cap and pull out the slide assembly. Tape the slide out of the way to avoid damage. Remove the manifold bolts at the cylinder and take away the manifold and carburetor as a unit. Plug the cylinder intake port with a clean piece of rag to keep foreign matter out.

8. Disconnect the electrical wiring at the plastic coupler. Remove the spark plug cap. Loosen the plug.

9. Disconnect the clutch cable at the engine.

10. Remove the two engine mounting plate bolts on the right engine mounting plate. Remove the long engine mounting bolts (two). The lower bolt is removed by loosening it from the left-side. Remove the right-side engine mounting plate.

11. Protect the frame tubes with a covering of some sort. Remove the engine by moving it forward in the frame, then swing the back of the engine out to the right and take the engine out of the frame.

12. Installation is the reverse of the above. Tighten engine mounting bolts to 15-22 ft lbs.

13. When installing the muffler, check the gasket for damage and replace it if necessary. Tighten the muffler bolt and the cylinder mounting nuts gradually.

CL70

1. Remove the gearshift lever pinch-bolt, and carefully pull the lever off the splined shaft.

2. Remove the footpeg step bar.

3. Remove the rear portion of the left crankcase cover and disconnect the drive chain.

4. Remove the exhaust system.

5. Unbolt the carburetor intake manifold from the cylinder head.

6. Run down the clutch cable adjusters and disconnect the cable from the engine lever.

7. Disconnect the spark plug lead and loosen the plug.

8. Remove the battery cover and disconnect the wiring at the connector.

9. Disconnect the rear brake pedal return spring from the pedal.

10. Remove the engine mounting bolts and nuts and remove the engine from the frame.

11. Installation is the reverse of removal.

CT70/H

1. Remove the engine bash plate (two bolts).

2. Remove the exhaust system which is secured at the cylinder head and two places on the frame.

3. Remove the spark plug.

4. Unscrew the carburetor cap, pull out the slide assembly, and arrange it so that it is out of the way and won't be damaged when the engine is removed.

5. Remove the four bolts which se-

cure the crankcase protector downtubes to the frame near the steering head.

6. Remove the chain guard. Remove the left crankcase cover. Disconnect the drive chain.

7. Remove the two bolts beneath the engine which secure the skid plate portion of the crankcase protector, and remove it.

8. Remove the step bar (two bolts).

9. Disconnect the rear brake pedal return spring at its top mount.

10. Remove the carburetor intake manifold from the cylinder head.

11. Remove the two engine mounting bolts, and remove the engine.

12. Installation is the reverse of removal.

C65/M, C70/M, S65

1. Remove the air cleaner assembly (except S65).

2. Remove the fairing (if applicable).

3. Remove the exhaust system.

4. Remove the footpeg step bar.

5. Remove the tool box.

6. Unbolt the carburetor (C models) or the manifold (S65) from the cylinder head.

7. Run down the clutch cable adjuster and disconnect the cable from the engine lever.

8. Remove the pinch-bolts and take off the gearshift and kick-starter levers.

9. Remove the left-side crankcase cover. Disconnect the drive chain.

10. Remove the spark plug. Detach the spark plug lead from the clip on the right sidecover. Disconnect the starter motor lead and the electrical wiring.

11. Disconnect the rear brake pedal return spring and stoplight switch spring.

12. Support the engine while removing the rear mounting bolts; remove the engine from the frame.

13. Installation is the reverse of removal.

Z50

1. Remove the exhaust system.

2. Unscrew the carburetor cap, and pull out the throttle slide assembly. Secure it out of the way to avoid damage.

3. Remove the lead and loosen the spark plug.

4. Disconnect the magneto wiring at the plastic connector.

5. Disconnect the fuel line from the carburetor.

6. Remove the left crankcase cover. Disconnect the drive chain.

7. Remove the two engine mounting bolts while supporting the engine; remove the engine from the frame.

8. Installation is the reverse of removal.

TOP END

The following section deals with the removal and installation of the cylinder head, cylinder, piston, and related components. Inspection and service procedures for these and other common engine components are outlined in the "Engine Rebuilding" section in "General Infor-

mation." Specifications for individual models are given in the charts at the end of this section.

100/125 cc Models (1975 and Earlier)

REMOVAL

1. Removal of the top end necessitates removing the engine from the frame. Refer to the "Engine Removal and Installation" procedures.

2. Remove the breaker point cover. Scribe a line across the breaker plate to the engine to preserve ignition timing. Remove the two breaker plate screws and remove the plate. Remove the valve adjusting hole caps and loosen the adjusters.

3. Remove the bolt which secures the breaker cam. Pull the breaker cam and spark advance assembly off the camshaft.

4. Remove the two screws which hold the breaker point housing to the engine. Use an impact driver to loosen these screws. Remove the housing.

5. Loosen the cam chain adjuster screw locknut (on the crankcase) and unscrew the tensioner screw a few turns. Place a clean rag beneath the cam sprocket, and carefully remove the sprocket bolts. Remove the sprocket.

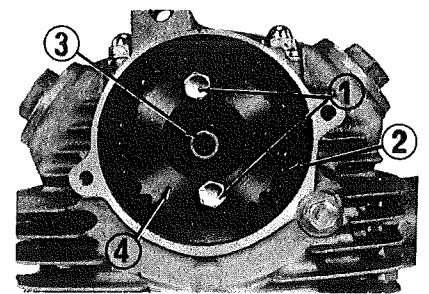

Sprocket bolts (1), cam chain (2), camshaft (3), and sprocket (4)

Loop a piece of wire around the cam chain and secure it to any fixed point to prevent the chain from falling into the crankcase.

6. Pull out the camshaft. Note that the camshaft will have to be turned to allow the intake and exhaust lobes to clear the opening through which the cam is removed. Perform this operation carefully. Hold the chain out of the way as the cam is removed.

7. Remove the cam chain tensioner mounting bolt in the head and detach the tensioner from its seat in the head.

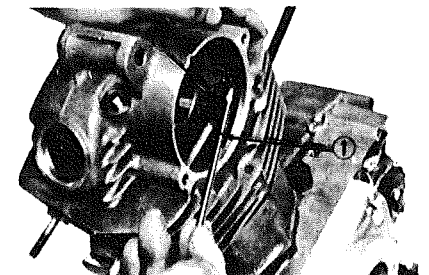

Prying the tensioner (2) out of its seat with a screwdriver (1)

Honda 4-Stroke Singles

8. Remove the cylinder head bolt beneath the breaker point housing. Remove the four capnuts on top of the cylinder head. Remove the cylinder head.

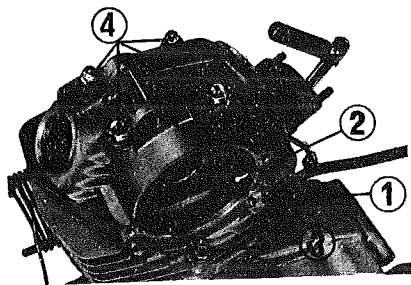

Cam chain tensioner mounting bolt (1), tensioner (2), cylinder head (3), and cylinder head capnuts (4)

9. Remove the cam chain guide from the cylinder. Lift the cylinder up on its studs until there is enough room to stuff a clean rag between the cylinder and the crankcase. This will catch any foreign matter or pieces of broken ring which might fall into the cases when the cylinder is removed.

10. After removing the cylinder, remove the piston wrist pin circlips with needlenose pliers. Push out the wrist pin with a suitable drift.

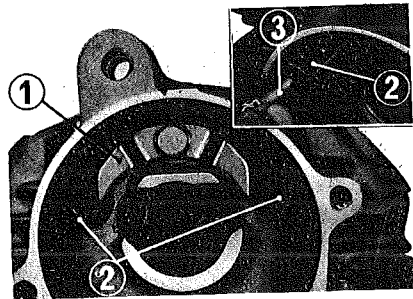

Remove the bolt which secures the rocker arm shaft retaining plate (1) and pull out the shafts (2) with a puller bolt (3) 6 mm thread diameter

11. To remove the rocker arms from the cylinder head, first remove the rocker arm shaft retaining plate. Thread a 6 mm bolt into the rocker arm shafts and pull them out of the head (the cylinder head bolt is 6 mm and can be used for this operation). Mark each rocker arm and shaft for position and keep the pairs together so that each rocker arm can be installed on its proper shaft.

INSTALLATION

1. Install one wrist pin circlip and place the piston on the connecting rod noting that the "IN" stamped on the crown must be located on the intake port side or that the arrow points toward the exhaust port.

Install the wrist pin and the other circlip.

NOTE: Always use new circlips; install them so that the end-gaps do not align with the cutouts on the piston.

Arrange the ring end-gaps so that they are 120° apart, but none should be perpendicular to or parallel with the wrist

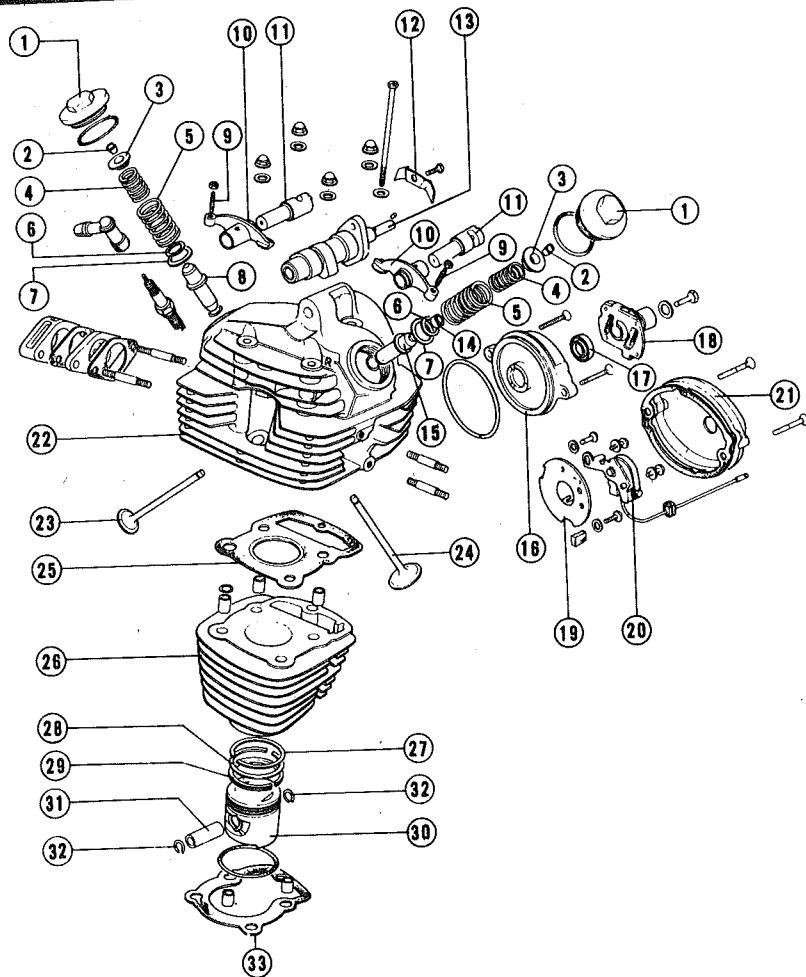

Top end assembly (100-125 cc, 1975 and earlier)

- | | | |
|--------------------------|-------------------------------------|-----------------------------|
| 1. Valve adjusting cap | 12. Rocker arm shaft retainer plate | 23. Exhaust valve |
| 2. Valve spring keeper | 13. Camshaft | 24. Intake valve |
| 3. Valve spring retainer | 14. Valve seal | 25. Cylinder head gasket |
| 4. Inner valve spring | 15. Valve guide | 26. Cylinder |
| 5. Outer valve spring | 16. Contact breaker housing | 27. Top compression ring |
| 6. Inner spring seat | 17. Oil seal | 28. Bottom compression ring |
| 7. Outer spring seat | 18. Spark advance mechanism | 29. Oil ring |
| 8. Valve guide | 19. Breaker plate | 30. Piston |
| 9. Adjusting screw | 20. Breaker points | 31. Wrist pin |
| 10. Rocker arm | 21. Breaker cover | 32. Wrist pin circlip |
| 11. Rocker arm shaft | 22. Cylinder head | 33. Cylinder base gasket |

pin. Lubricate the piston and rings with motor oil.

2. Fit the cylinder base gasket. Make sure that all O-rings and locating pins are installed and lower the cylinder over the piston, compressing the rings with your fingers as the piston enters the bore. Pull the cam chain up through the cylinder. Install the cam chain guide.

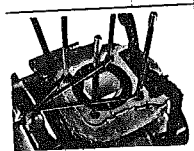

Cylinder locating pins (1), cam chain tensioner (2), and chain guide (3)

3. Assemble the rocker arms in the head if removed. Fit a head gasket, and install the head. Pull the cam chain through and tie it aside. Fit the cam chain tensioner into its seat and install the tensioner mounting bolts.

4. Tighten the cylinder head capnuts and bolt in a cross pattern and in gradual increments until the proper torque of 13-14.5 ft lbs is reached.

5. Lubricate and install the camshaft. Arrange the cam so that the locating pin for the spark advance mechanism points upward.

6. Remove the alternator rotor cover and turn the crankshaft so that the "T" mark on the rotor is aligned with the mark on the stator. The piston is now at top dead center. Install the cam sprocket on the camshaft, looping the cam chain over it, so that the "0" mark on the sprocket is aligned with the mark on the top of the cylinder head. Be sure that the rotor "T" mark is still aligned. Fit the

Honda 4-Stroke Singles

camshaft sprocket bolts and tighten them to 6-9 ft lbs. These bolts should be secured with thread locking compound. The valve timing is now adjusted.

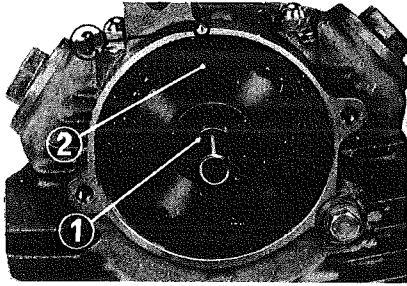

The "O" mark on the cam sprocket (2) must align with the mark (3) on the head with the piston positioned at TDC

7. The remainder of the procedure is the reverse of disassembly. Be sure to engage the slot in the timing advance mechanism with the pin in the camshaft. Adjust the cam chain, check ignition timing, etc., before starting the engine. Check cylinder head torque after the engine has been run and cooled off.

100/125 cc Models (1976 AND LATER)

1. The cylinder head on 1976 models has been modified to a two-piece type instead of the original single-piece casting. The head is now fitting with a cover secured by four allen bolts.

This change has been made to the following units: CB100E-1300001, CB125S-1300001 and subsequent.

2. Removal, disassembly, and installation of the top end components is performed in the same manner as for the 1975 and earlier engines. It is not necessary to remove the cylinder head cover in order to remove the camshaft or rocker arms. Its removal, however, may facilitate removal of valves and inspection of cam bearings.

3. Refer to 100/125 cc (1975 and Earlier) for procedures.

Specifications for the 125cc engine (1976) have been changed. Be sure to refer to the correct chart at the end of this section.

4. When assembling, be sure the oil seal rubber near the right-side cam bearing is in place. Use gasket sealer on the cylinder head cover mating surface.

90 cc Models

REMOVAL

1. The cylinder head, cylinder, and piston may be removed with the engine still in the frame.

2. Remove the exhaust system and the carburetor manifold from the cylinder head.

3. Remove the valve adjustment caps; remove the breaker point cover.

4. Disconnect the point wire. Mark the position of the breaker plate relative to the point housing to facilitate ignition timing upon assembly. Remove the breaker plate screws and pull off the plate.

5. Remove the bolt from the end of

the camshaft. Pull off the timing advance mechanism.

6. Remove the dowel pin from the camshaft. Remove the three phillips screws which secure the point housing to the head and remove the housing and its gasket.

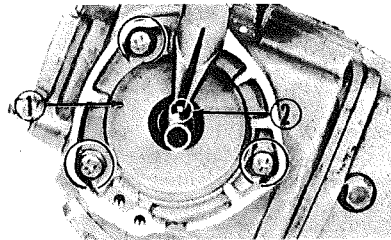

Remove the camshaft dowel pin (2); then remove the three screws and the point housing

7. Rotate the engine so that the "O" mark on the cam sprocket aligns with the notch on the cylinder head. The sprocket bolts will be in line with the centerline of the cylinder.

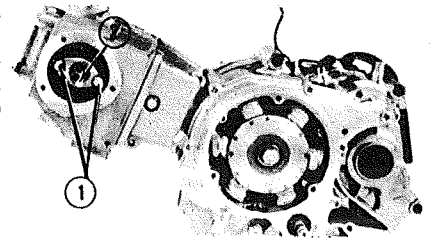

Position the piston at TDC on the compression stroke before removing the head by aligning the sprocket "O" mark with the top of the head. The sprocket bolts (1) will align with the cylinder centerline as illustrated.

The piston is now at top dead center on the compression stroke.

8. Remove the two cam sprocket bolts.

CAUTION: The cylinder head nuts must remain tightened when removing the sprocket bolts.

9. Remove the camshaft. Take out the sprocket.

10. Loosen each of the four cylinder

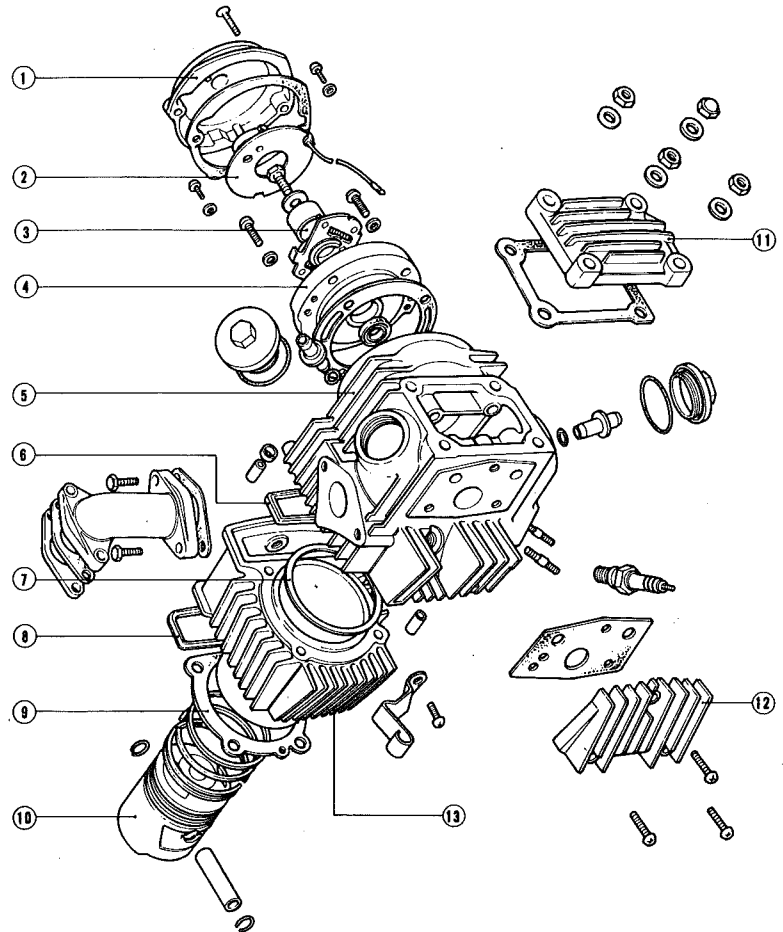

Top end assembly (90 cc)

- | | |
|-----------------------------|-------------------------------------|
| 1. Point cover | 8. Cam chain chamber gasket (lower) |
| 2. Breaker points | 9. Cylinder base gasket |
| 3. Timing advance | 10. Piston |
| 4. Point housing | 11. Cylinder head cover |
| 5. Cylinder head | 12. Head cover, right-side |
| 6. Cam chain chamber gasket | 13. Cylinder |
| 7. Head gasket | |

Honda 4-Stroke Singles

head nuts $\frac{1}{4}$ turn at a time in an "X" pattern until they are loose; then remove them. Lift off the cylinder head. Remove the gasket.

11. Remove the cam chain guide roller pin from the left-side of the cylinder.

12. Slowly pull off the cylinder, taking care that the piston does not strike the engine when the cylinder is removed.

13. After removing the cylinder, remove the piston wrist pin circlips with a needlenose pliers. Push out the wrist pin with a suitable drift.

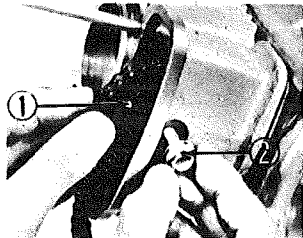

Remove the cam chain roller pin (2) and the roller (1)

14. Remove the cylinder head cover and gasket from the head.

15. Remove the finned cover from the right-side of the head. Take off the gasket. Pull out the rocker arm shafts with needlenose pliers, and remove the rocker arms.

NOTE: Keep the rocker arms with their respective shafts and install them in their original locations when the engine is assembled.

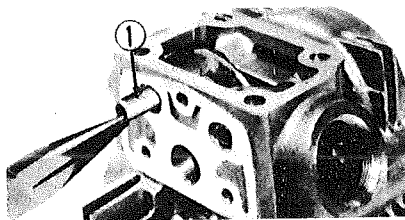

Removing a rocker arm shaft

INSTALLATION

1. Use new wrist pin circlips. Install one circlip and place the piston on the rod so that the arrow mark on the piston crown is facing the front of the engine (exhaust side) or the "IN" stamped on the crown is on the intake side. Install the other circlip. Be sure that both are properly seated in their grooves. The gaps in the circlips should not align with the cut-outs on the piston.

2. Arrange the piston ring end-gaps so that they are 120° apart, but none of them are at right angles to or parallel with the wrist pin. Lubricate the piston skirt and the rings with motor oil.

3. Clean off the cylinder base and the crankcase mating surface. Fit a new base gasket and a cam chain chamber gasket.

4. After ensuring that any cylinder guide pins or O-rings are in place, install the cylinder. As the cylinder is moved down on the studs, pull the cam chain through. Compress the piston rings carefully as the piston enters the bore. Place the piston at top dead center.

5. Install the cam chain guide roller and pin.

6. Assemble the cylinder head, refitting the rocker arms and shafts, the right-side cover and the top cover. Use new cover gaskets. Rocker arm shafts should be lubricated before installation.

7. Fit a new head gasket and upper cam chain chamber gasket. Fit the cam sprocket to the chain.

8. Install the head, drawing the cam sprocket up through the head as it is installed. Loop a length of wire through the sprocket and wire it to the head to keep it in place while torquing the head nuts.

9. Install and tighten the head nuts, noting that the lower left-hand nut is a capnut fitted with a copper washer.

Tighten the nuts in gradual increments in an "X" pattern until a final torque of 13-16 ft lbs is reached.

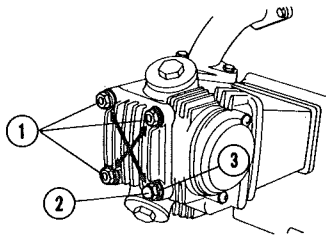

Torque the head nuts gradually and in an "X" pattern; be sure that the capnut (2) and copper washer (3) are in the right place

10. Check the timing marks on the alternator rotor ensuring that the "T" mark is aligned with the index mark (piston at top dead center). Position the cam sprocket so that the "O" mark is aligned with the notch in the cylinder head.

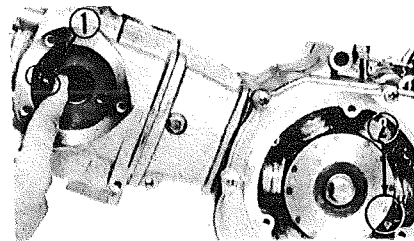

Line up the alternator rotor "T" mark with the crankcase mark (2), then position the cam sprocket so that the "O" mark is at the very top of the head (1) and aligned with the notch

11. Loosen the valve adjustment screws several turns. Install the camshaft. The dowel pin hole in the camshaft must face the notch in the cylinder head. Use thread locking compound on the sprocket bolts, tightening them to the proper torque.

12. Install a new oil seal into the point housing. Grease the lips of the seal before installing the housing.

The use of a seal guide on the end of the camshaft is recommended to avoid damaging the lips of the seal when the housing is installed. (Tool No. 07043-1280100).

13. Install the housing, using a new gasket behind it. Install the dowel pin on the camshaft. Fit the spark advance mechanism, cam bolt, etc. The remainder of installation is the reverse of removal.

Adjust the cam chain, valves, and ignition timing, and recheck these after a few miles of operation.

50-70 cc Models (Except XR75)

REMOVAL

1. The engine need not be removed from the frame to remove the cylinder head and cylinder. Remove the exhaust system and the carburetor and manifold from the cylinder.

2. Remove the magneto or alternator rotor cover. Remove the spark plug and the valve adjuster caps. Turn the engine over until the intake valve goes down and comes up, and turn it a bit farther so that the "T" mark on the rotor aligns with the stationary index mark.

The piston is now at top dead center on the compression stroke (both valves closed).

3. Loosen each cylinder head cover nut $\frac{1}{4}$ of a turn at a time until they are loose, then remove them. Note that one or two of the nuts are different and must be installed in the location from which they were removed.

On most models, there is one hex nut and three capnuts; an oil sealing washer is fitted beneath the hex nut.

4. Tap the head cover lightly with a plastic mallet to free it if stuck.

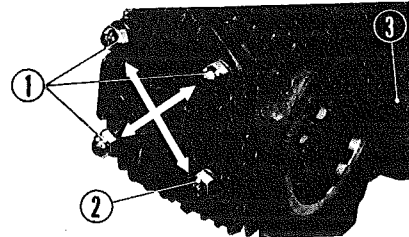

Remove the three capnuts (1); and the hex nut (2), to remove the cylinder head cover. Remove the head bolt (3) before attempting to remove the head (50-70 cc)

5. Remove the bolt from the right-side of the cylinder head. This will enable the left-side cover to be removed.

6. Remove the two screws on the right-side cylinder head cover and remove the cover.

7. Check that the piston is at TDC (the "O" mark on the cam sprocket will be toward the top of the head).

8. Remove the three sprocket mounting bolts, and push in on the camshaft to disengage it from the sprocket. Remove the sprocket after disengaging it from the cam chain.

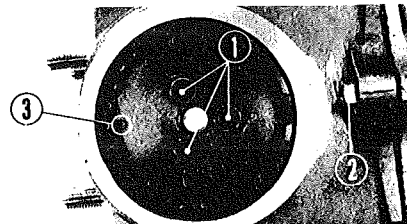

Align the sprocket mark (3) with the top of the head before removing the sprocket bolts (1)

NOTE: It may be necessary to hold the camshaft in position while removing

Honda 4-Stroke Singles

the sprocket bolts and this can be done if the engine is in the frame by engaging the transmission except for centrifugal clutch models. If the engine is not in the frame, secure the magneto rotor or the countershaft sprocket.

9. Remove the cylinder head mounting bolt on the left-side of the head. Remove the head, tapping around the mounting surface with a plastic mallet if it is stuck.

10. When the head is removed, remove the two locating pins at the head mating surface and ensure that they are in place when the head is refitted. To

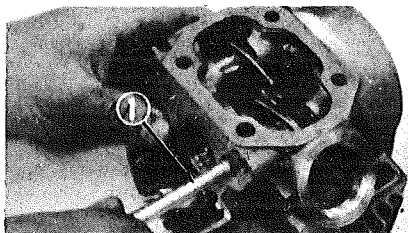

Removing the rocker arm shaft with a 6 mm puller bolt

remove the rocker arms, thread a 6 mm bolt into the right-side of the rocker arm shafts and pull them out. Keep each rocker arm shaft with its own rocker arm for proper installation. Push the camshaft out of the head.

NOTE: The cylinder head or cylinder mounting bolt can be used to remove the rocker arm shafts.

11. Unscrew and remove the cam chain guide roller pin from the left-side of the cylinder and remove the guide roller.

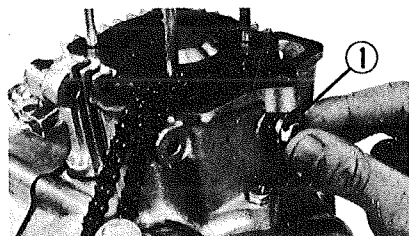

Removing the cam chain guide roller pin (1)

12. Remove the cylinder mounting bolt on the left-side and pull off the cylinder. Do not allow the piston to strike the studs as it comes out of the cylinder. Check the location of the two hollow dowel pins on the cylinder studs. Remove these and make sure that they are installed when assembling the top end.

13. To remove the piston, remove the wrist pin circlips with needlenose pliers and push out the wrist pin.

NOTE: Use steady pressure while removing the wrist pin. Support the piston with your other hand. Do not strike or attempt to force out the pin.

INSTALLATION

1. Install one wrist pin circlip and place the piston on the connecting rod. The triangular mark on the piston crown

must be positioned on the cam chain side. Insert the wrist pin and the other circlip. Use new circlips and be sure that they are properly seated. Arrange the circlip end-gaps so that they do not align with the cutouts on the piston. Arrange the piston rings so that the end-gaps are 120° apart, but are not perpendicular to or parallel with the wrist pin. Lubricate the wrist pin, rings, and piston skirt with motor oil.

2. Be sure that the O-ring is in place in the crankcase oil passage and the hollow dowel pins are installed on the cam chain side studs. Fit a new cylinder base gasket. Install the cylinder, compressing the rings with your fingers as the piston enters the bore. Feed the cam chain through the cylinder as it is seated. Install and tighten the cylinder mounting bolt.

3. Install the cam chain guide roller and the roller pin.

4. Install the two hollow pins on the studs: one on the top right stud, the other on the left bottom. Fit the O-rings to the oil passage and to the stud oil passage; fit the head gasket.

5. Install the head, complete with rocker arms and cam, threading the cam chain with its sprocket through, and securing them with a length of wire or a screwdriver.

6. Turn the magneto rotor so that the "T" mark on the rotor is aligned with the "index" mark on the crankcase. Set the cam sprocket "0" mark at the top of the head. Install and tighten the sprocket bolts to 4-7 ft lbs. Thread locking compound should be used on these bolts. Lubricate the top end components.

7. The remainder of the procedure is the reverse of disassembly. Note that the cylinder head cover hex nut (on most models) and its copper washer are installed on the lower left stud. Install the head mounting bolt. Tighten the head cover nuts in a cross pattern and in increments of 2-3 ft lbs until the proper torque of 6.5-8.7 ft lbs is reached. Adjust the cam chain and tappet clearance before starting the engine.

XR75

REMOVAL

1. The top end can be removed with the engine in the frame. Remove the gas tank, exhaust system, carburetor, and manifold.

2. Remove the magneto rotor cover. Remove the spark plug.

3. Remove the cylinder head cover.



Cam sprocket positioned for removal. Note "O" mark on the sprocket (1) and the cam housing mark (arrow). Sprocket bolts (2 and 3) are not interchangeable.

4. Turn the engine over until the "O" mark on the cam sprocket is aligned with the mark on the cam housing. Unscrew and remove the two cam sprocket bolts.

NOTE: The bolts are not interchangeable. Mark the location of each so that they can be installed in their original locations.

5. Remove the cam sprocket. Loop a length of wire around the chain and secure it so that it doesn't fall into the cylinder.

6. Remove the three hex nuts and one capnut and take off the camshaft housing complete with cam and rocker arms.

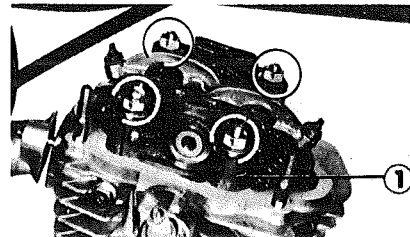

Remove the camshaft housing (1) after removing the four nuts circled

7. Thread an 8 mm bolt into the rocker arm shafts and pull them out. Mark each and the rocker arms for proper installation. Remove the cam.

8. Remove the cam chain tensioner set plate bolt from the cylinder head. Pull out the tensioner adjuster.

9. Remove the cylinder head. If stuck, strike carefully with a plastic mallet. When removing the head, be sure that the cam chain does not fall into the crankcase.

Note the location of the dowel pins and O-rings on the head-cylinder mating surface. Be sure that they are correctly installed when assembling the engine.

10. Remove the cam chain guide. It can be pulled out of the cylinder. Loosen the cam chain tensioner bolt.

11. Remove the cylinder. When the cylinder is lifted off the crankcase, stuff a clean rag between the cylinder and case to catch any pieces of broken ring, dirt, etc.

Note the location of any dowel pins or O-rings between the cylinder and the case. These must be in their proper locations when assembling the engine.

12. Remove the wrist pin circlips with needlenose pliers.

NOTE: Keep the rag in place while doing this.

13. Push out the wrist pin. If the pin resists removal, the piston crown may be heated gently with a propane torch.

CAUTION: Never strike the wrist pin to remove it. Use steady pressure only. Support the piston with one hand while the wrist pin is removed.

INSTALLATION

1. The piston must be installed so that the "IN" marking on the crown is on the intake side. Use new wrist pin circlips.

Circlips should be firmly seated in their grooves. The open ends should not align with the piston cutout.

Honda 4-Stroke Singles

2. Arrange the piston rings so that the end-gaps of the two compression rings and the oil ring expander are 120° apart. Arrange the end-gaps of the two oil rails about 45° on either side of the expander end-gap.

None of the ring end-gaps should be perpendicular to or parallel with the wrist pin.

3. A new cylinder base gasket must be used. Be sure that any dowel pins or O-rings are in place before installing the cylinder.

4. Lubricate the piston assembly with motor oil before fitting the cylinder. Pull the cam chain through the cylinder as it is installed. Install the chain guide.

5. Use a new head gasket. Install the head, making sure that any dowel pins or O-rings are in place.

6. Install the cam housing, cam, and rocker arms in the head. Turn the cam so that both valves are closed. Clean the threads of the cylinder studs, and oil them lightly. Fit the cam housing nuts, and tighten them in a cross pattern until the correct torque (5.8-8.7 ft lbs) is reached.

7. Remove the rotor cover. Turn the engine over until the "T" mark on the rotor aligns with the index mark.

8. Install the cam sprocket so that the "0" mark on the sprocket aligns with the mark on the cam housing.

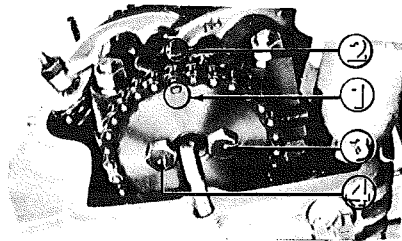

With the piston at TDC, align the sprocket mark (1) with the housing mark (2), then install the bolts (3 and 4)

9. Fit the sprocket bolts, noting their proper locations. Use thread locking compound on these bolts. Torque to 5.8-8.7 ft lbs.

10. The remainder of the procedure is the reverse of removal. Adjust the cam chain and valve clearance before starting the engine.

TOP END SERVICE

Service and inspection procedures for the components in the top end are outlined in the "Engine Rebuilding" section in "General Information," while specifications for individual models are given in the specifications charts at the end of this section; however, note the following:

1. Early model 100s (up to Frame No. 200000) were equipped with straight-wound valve springs. If the later progressively-wound springs are fitted as a replacement, they must be replaced in sets.

2. Some models use stellite-tipped valves. Attempting to resurface the valve stem will wear away the hardened stellite surface.

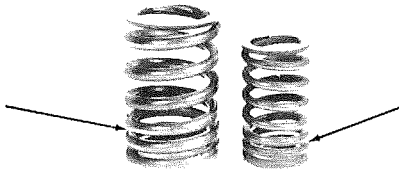

Progressively-wound valve springs are installed with the close coils against the head

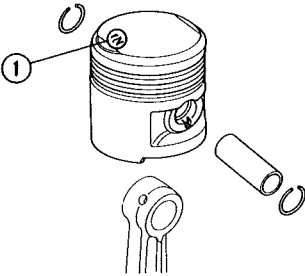
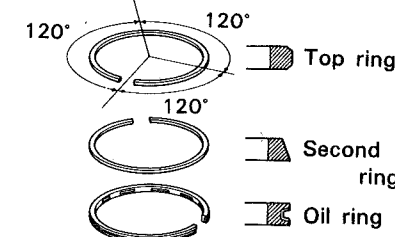

Ring end-gaps should be spaced 120° apart. The piston must be installed so that the "IN" mark is toward the intake side on the head. Note the difference between the top and bottom compression rings.

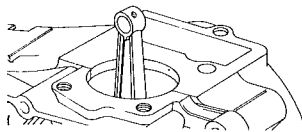
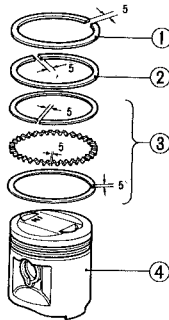

On models with multi-piece oil rings, the end-gap of the expander should be 120° from the lower compression ring, and the two oil rail end-gaps should be about 45° on either side of the expander end-gap

3. Before installing the rings on the piston, first note that the two compression rings are not interchangeable in most cases. The wedge-shaped ring is the lower compression ring.

Also note that rings must always be installed so that the manufacturer's mark

(the small letter near the end-gap) faces up when the rings are in place.

4. If two-rail oil rings are used, install one rail on the piston below the oil ring groove. Install the oil rail expander in the groove, then move the lower rail into the groove. Install the upper oil rail.

5. Arrange the ring end-gaps 120° apart, but do not position any end-gap at the very front or the very back of the piston (perpendicular to the wrist pin), or directly above the wrist pin holes.

If a two-rail oil ring is used, position the end-gap of the oil ring expander 120° from the lower compression ring, then position the end-gaps of the oil rails about 45° (20-30 mm) on either side of the expander end-gap.

CRANKCASE COVER COMPONENTS

Right Crankcase Cover Components

100-125 CC MODELS

Clutch, oil pump and filter, and the gearshift mechanism are accessible after removing the right crankcase cover. To remove the kick-starter, it is necessary to split the cases. Refer to "Lower End and Transmission."

Removal and Installation

1. Drain the oil. Remove the exhaust system and the right footpeg. Remove the kick-starter lever. Disconnect the clutch cable, and the tach cable, if fitted. Remove the right crankcase cover.

2. Remove the oil filter rotor cap (three screws). Remove the rotor nut. A special wrench is needed to remove the nut. Remove the rotor.

3. Remove the oil pump gear cover. Remove the oil pump gear and shaft. The oil pump is secured by two bolts. Remove them and remove the pump.

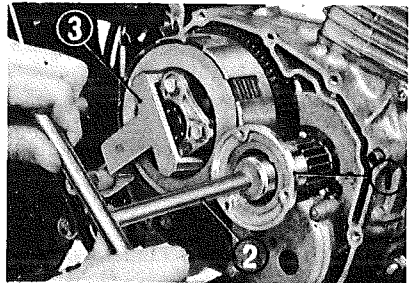

Removing the oil filter rotor nut with the special wrench (2). Note the clutch holder (3). (100-125 cc)

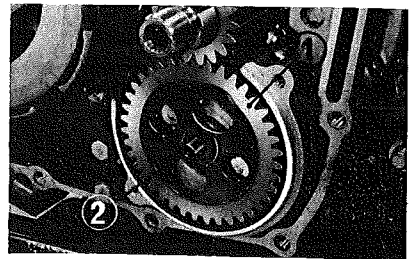

Oil pump gear (1) and shaft (2)

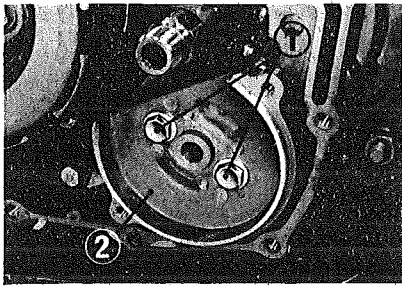

Oil pump (2) and securing bolts (1)

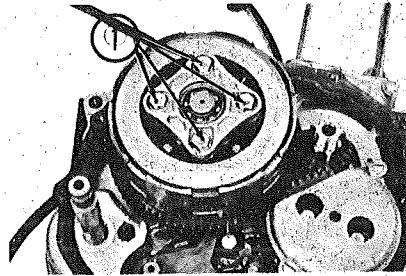

Clutch lifter plate bolts (1)

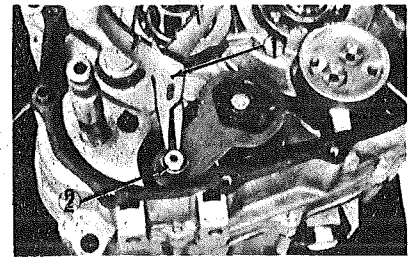

Removing the shift plate circlip (2)

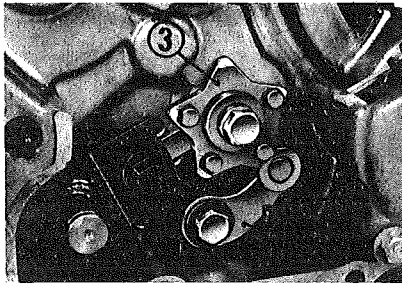

Remove the gearshift drum stopper and spring (1 and 2) and stopper plate (3)

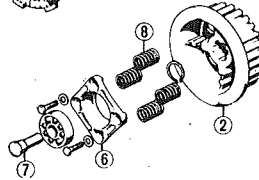
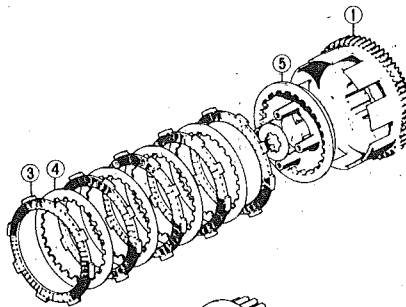

Clutch assembly (100-125 cc)

1. Clutch housing
2. Clutch hub
3. Friction plate
4. Steel plate
5. Pressure plate
6. Lifter pin
7. Lifter pin
8. Clutch springs

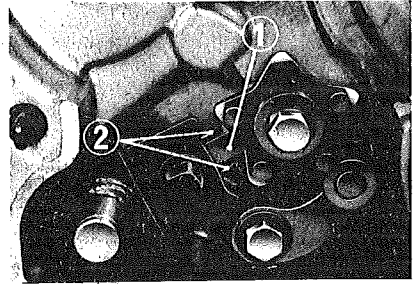

Upon assembly, be sure that the ends of the return spring (2) are installed on either side of the crankcase boss (1)

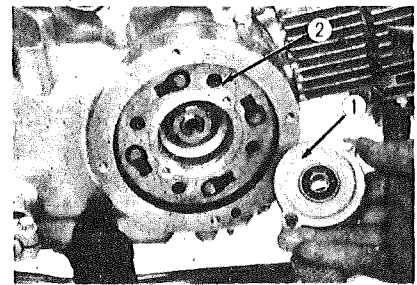

Clutch housing (2) and cover (1) (90 cc)

4. Gradually loosen the clutch lifter plate bolts, then remove the bolts along with the lifter pin, lifter plate, lifter bearing, and springs.

5. Remove the crankshaft primary gear. Remove the clutch hub snap-ring, housing as a unit. The clutch lever in the right cover on TL125 and 100/125(76) can be removed after removal of the cotter pin. Be sure the spring is correctly installed.

6. To remove the gearshift linkage, remove the circlip on the shift shaft and remove the shift plate from the shaft.

7. Remove the gearshift drum stopper and spring. Remove the shift drum stopper plate. Both of these parts are secured by single bolts.

8. Remove the gearshift lever (left-side). Pull the gearshift shaft out from the right-side.

9. Refer to "Component Inspection," which follows.

10. Assembly is the reverse of the above. Note the following points:

- a. The stopper plate is equipped with a locating pin hole. Match it with the pin in the shift drum. Install the gearshift shaft so that the ends of the shaft return spring are located on either side of the boss on the crankcase;
- b. Tighten the clutch lifter plate bolts progressively until a torque of 5.6-8.7 ft lbs is reached;
- c. Before installing the oil pump, be sure that the O-rings are installed;
- d. When installing the oil filter, note that the rotor washer is marked for proper installation. The "outside" side of the washer must face out. Tighten the rotor nut to 29-36 ft lbs.

90CC MODELS

Clutch, oil pump, primary driven gear, and the gearshift mechanism are accessible after removing the right-side cover. To remove the kick-starter mechanism, it

is necessary to split the cases. Refer to "Lower End and Transmission."

Removal and Installation

1. Drain the oil. Disconnect the clutch cable from the lever at the engine (if fitted).

2. On models with a tubular sub-frame (ST/CT models), remove the foot-pegs and the sub-frame.

3. Slack off the rear brake adjuster nut several turns. Remove the pinch-bolt and pull off the kick-starter.

4. Remove the clutch cover plate. Remove the right crankcase cover. Remove and discard the cover gasket.

5. On centrifugal clutches, remove the clutch lifter lever and the lifter.

6. Remove the clutch housing cover usually secured by two phillips screws.

7. Bend down the tab on the clutch

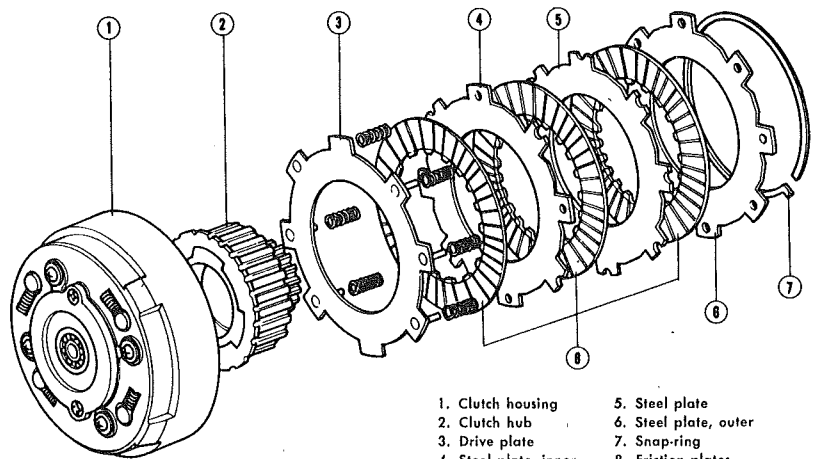

1. Clutch housing
2. Clutch hub
3. Drive plate
4. Steel plate, inner
5. Steel plate
6. Steel plate, outer
7. Snap-ring
8. Friction plates

Centrifugal clutch components

Honda 4-Stroke Singles

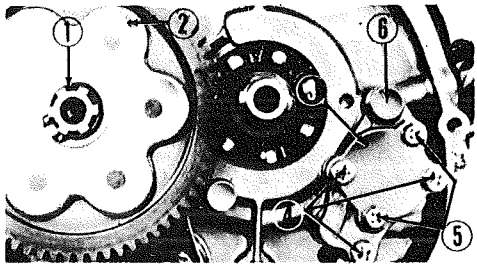

Primary driven gear (2), snap-ring (1), oil pump (3), securing screws (4), hex bolt (6), and pump cover screws (5)

nut lockwasher. Remove the clutch hub nut with the special tool. The crankshaft must be secured while doing this. Remove the clutch assembly.

8. If disassembly of the clutch is required, compress it using the special Honda tool, or compress the assembly in a soft-faced vise. Remove the large snap-ring on the inner side. Carefully remove the clutch from the vise or tool (it is under spring pressure when compressed), and separate the components: steel and friction plates, free springs (centrifugal clutch), clutch hub, and gears.

If further disassembly is desired, remove the clutch damper springs in the clutch housing. Remove the phillips screws from the outer side of the housing and separate drive plate, clutch springs, and housing.

To complete disassembly, remove the clutch weight stopper ring from the drive plate.

9. Remove the oil pump by removing the hex bolt and three phillips screws. Remove the oil filter screen.

10. Remove the snap-ring to remove the large primary driven gear.

11. Remove the pinch-bolt and pull the foot gearshift lever off the splined shift shaft. Remove the shift drum stopper. Disengage the fingers of the shift arm from the shift drum pins and pull the shift shaft assembly out of the case. Remove the phillips screw and the shift drum stopper plate (if desired).

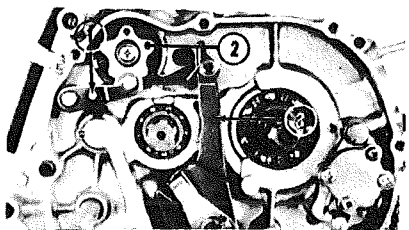

Shift drum stopper (1), stopper plate (2), and shift arm (3)

12. Refer to "Component Inspection," which follows.

13. Installation is the reverse of removal. Note the following points:

a. To assemble the clutch, first assemble the drive plate and spring assembly. Place the clutch housing over it and compress both as shown while fitting the housing phillips screws;

b. Use the special tool or a substitute to compress the clutch assembly while the snap-ring is fitted;

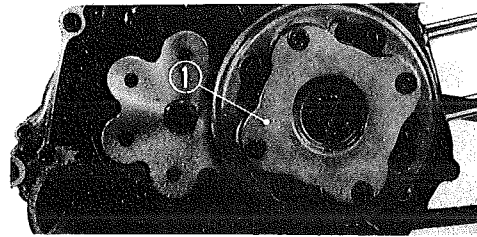

Clutch cover (50-70 cc)

3. Take out the screws and remove the right crankcase cover.

NOTE: On most models the cover screws are of different lengths; note their locations to install properly. Note the dowel pins between the case and cover.

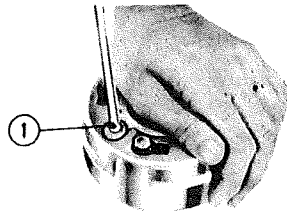

Assembling the clutch

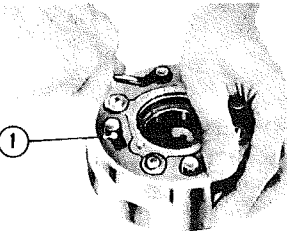

Installing the damper springs

c. Install the damper springs with a screwdriver as illustrated;

d. The shift drum stopper plate must be firmly secured. Use an impact driver or thread locking compound to tighten it;

e. Be sure that the gearshift lever return spring pin is secured in the crankcase. Install the gearshift shaft assembly, locating the ends of the return spring on either side of the stopper pin and engaging the fingers of the shift arm with the shift drum pins;

f. Install the shift drum stopper, so that the roller bears against one of the detents of the shift drum stopper plate;

g. Check the operation of the shift mechanism;

h. Torque the hub nut to 54-64 ft lbs. Bend up the tab on the lockwasher;

i. Before refitting the crankcase cover, be sure that the dowel pins are in place.

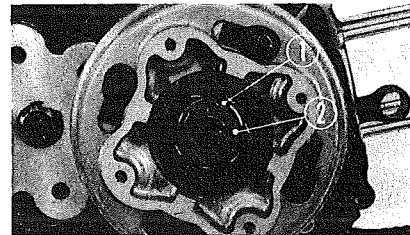

Bend up the tab of the lockwasher (1) to remove the clutch hub nut (2)

4. On centrifugal clutches, remove the clutch lifter lever and the lifter.

5. Remove the clutch housing cover.

6. Bend down the tab on the clutch nut lockwasher. Remove the clutch hub nut with the special wrench. The crankshaft must be secured while doing this.

Remove the clutch assembly from the crankshaft.

7. If disassembly of the clutch is desired, compress it using the special Honda tool, or compress the assembly in a soft-faced vise. Remove the large snap-ring on the inner side. Carefully remove the clutch from the vise or tool (it is under spring pressure when compressed) and separate the components: steel and friction plates, free springs (centrifugal clutch), clutch hub, and gears.

If further disassembly is desired (centrifugal clutches), remove the clutch damper springs in the housing. Remove the phillips screws from the outer side of the housing and separate the drive plate, clutch springs, and housing.

8. Remove the three oil pump mounting screws to remove the oil pump. Remove the filter screen.

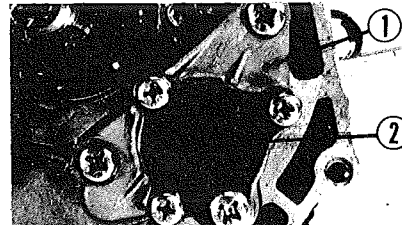

Oil pump (1) and cover (2)

9. Remove the circlip to remove the large primary driven gear. Remove the circlip from the kick-starter shaft. Detach the kick-starter return spring from the

50-70CC MODELS (EXCEPT XR75)

The clutch, oil pump, primary driven gear, gearshift assembly, and kick-starter return spring and spring retainer are accessible after removing the right crankcase cover.

Removal and Installation

1. Drain the oil. Remove the crankcase bash plate (if fitted).

2. Disconnect the clutch cable at the engine lever (manual clutch models); remove the kick-starter lever.

crankcase, and remove the spring and retainer.

10. Remove the shift drum stopper and spring. Remove the gearshift lever from the left-side of the engine. Loosen the shift drum stopper plate screw, disengage the fingers of the shift arm from the shift drum dowel pins, and pull the gearshift shaft out of the crankcases.

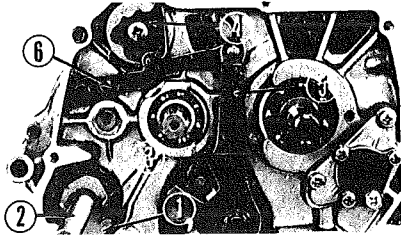

Right crankcase cover components (SL70 shown)

- | | |
|---------------------------------|-----------------------------|
| 1. Kick-starter spring retainer | 4. Shift drum stopper plate |
| 2. Kick-starter shaft | 5. Shift arm |
| 3. Return spring | 6. Shift drum stopper |

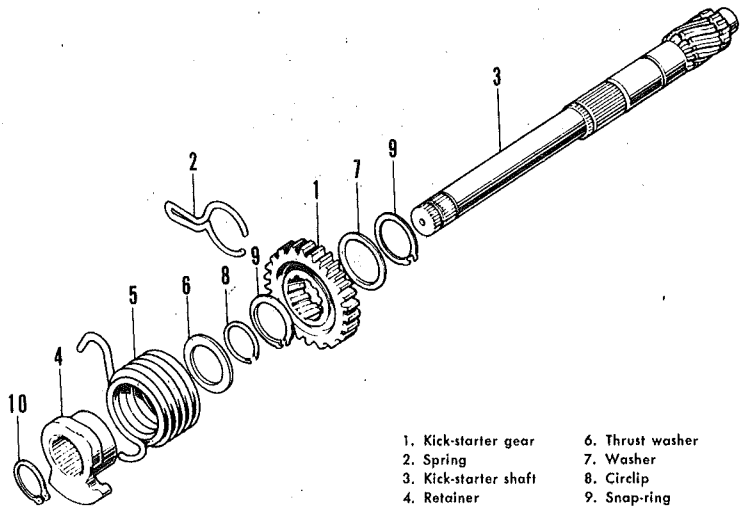

- | | |
|-----------------------|------------------|
| 1. Kick-starter gear | 6. Thrust washer |
| 2. Spring | 7. Washer |
| 3. Kick-starter shaft | 8. Circlip |
| 4. Retainer | 9. Snap-ring |
| 5. Return spring | 10. Circlip |

Kick-starter components (50-70 cc)

11. Refer to "Component Inspection," following.

12. Installation is the reverse of removal. Note the following points:

- The shift drum stopper plate screw should be secured with thread locking compound or an impact driver;
- Be sure that the gearshift lever return spring pin is secured in the crankcase. Install the gearshift shaft assembly, locating the ends of the return spring on either side of the stopper pin and engaging the fingers of the shift arm with the shift drum pins;
- Install the shift drum stopper, so that the roller bears against one of the detents of the shift drum stopper plate;
- Check the operation of the shift mechanism;
- Install the kick-starter return spring and spring retainer. One end of the spring should engage the crankcase, and the pawl on the retainer should rest against the stopper boss of the crankcase. Install the kick-starter shaft circlip;
- The collar installed on the crankshaft behind the clutch is fitted with the larger diameter side toward the engine. The clutch should be assembled before fitting it to the crankshaft;
- Tighten the clutch nut to 27.5-32.5 ft lbs, and bend down the tab on the lockwasher;
- When fitting the cover, be sure that the dowel pins are in place and the screws are correctly located. They are of different lengths.

XR75

Removal and Installation

- Drain the oil. Remove the exhaust pipe. Remove the kick-starter arm. Disconnect the clutch cable from the lever at the engine.
- Remove the skid plate and footpeg.
- Remove the right crankcase cover screws and tap lightly on the cover with a plastic mallet to free it if necessary.
- Remove the oil filter screen.
- Remove the centrifugal oil filter rotor cover (three screws), and remove the rotor nut with the special wrench. Keep the crankshaft from turning by jamming the primary gear with a block of hardwood, or by engaging the transmission and applying the rear brake.
- Remove the rotor and the primary gear.
- Remove the oil pump gear cover, then the pump assembly.
- Remove the clutch lifter plate bolts, loosening them evenly. Remove the clutch lifter plate and springs.
- Remove the circlip from the clutch shaft, and take out the clutch hub and plates as an assembly.
- Remove the splined washer and the clutch housing.
- Remove the shift drum stopper. Remove the stopper plate.
- Remove the gearshift lever from the left-side of the engine. Pull out the shifter return spring and shaft from the right-side. Do not lose the small shifter damper spring.

13. Refer to "Component Inspection," following.

14. Assembly is the reverse of the above.

Note the following points:

- Check the stopper and stopper plate for proper operation after tightening the bolts;
- Be sure to fit the splined washer to the clutch shaft after installing the housing;
- The oil pump O-rings and gasket should be replaced with new ones. The gasket must not contact the rotor. Do not forget to install the tach gear thrust washer;
- Tighten the clutch bolts gradually and evenly. Adjust the clutch after assembly.

Left Crankcase Cover Components

The left crankcase cover contains the alternator or magneto, the countershaft sprocket, and the cam chain tensioner on some models.

All components can be removed for service with the engine in the frame.

Certain precautions should be observed when handling these components:

- The rotor must be removed with a special puller. Do not attempt to pry the rotor off the tapered crankshaft;
- Do not heat or strike the rotor as this may affect its magnetic properties;

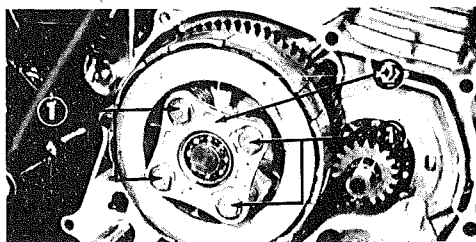

Clutch lifter plate (2) and bolts (1)

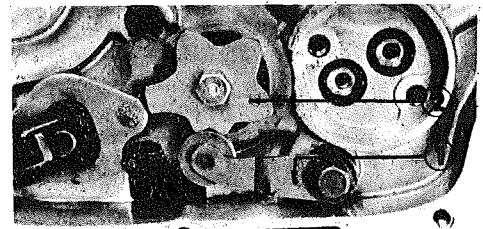

Shift drum stopper (1) and stopper plate (2)

Honda 4-Stroke Singles

c. Do not drop the rotor once it is removed. Place it where it will not pick up stray bits of metal;

d. Be sure that the rotor is perfectly clean before installation. Push it on its shaft (note the woodruff key) and tighten the rotor bolt or nut to seat it. Do not strike it. Some oil applied to the crankshaft taper will facilitate future removal of the rotor;

e. Be sure that all electrical wiring is properly routed and seated in the rubber grommets provided before installing the crankcase covers. Be certain that the cover will not pinch the wires, or that the wiring will not touch any moving part;

f. Be sure that parts such as the rotor and countershaft sprocket bolts are tightened to the proper torque. Refer to the "Torque Specifications" chart at the end of this section.

100-125 cc Models

REMOVAL AND INSTALLATION

1. Drain the oil. Remove the alternator wiring at the plastic coupler. Remove the gearshift lever.

2. Remove the alternator rotor cover. Remove the countershaft sprocket cover. Disconnect the neutral switch wire if fitted. Remove the forward section of the left crankcase cover.

3. Remove the screws securing the alternator stator. Secure the rotor, and remove the rotor bolt. Using the special puller, remove the rotor.

4. Early models: remove the cam chain tensioner arm pivot bolt, and take out the tensioner components.

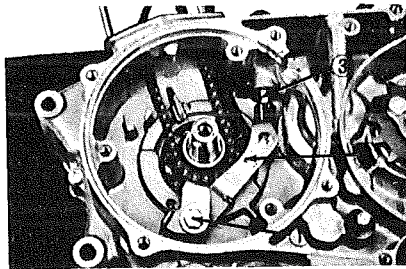

Cam chain tensioner bolt (1), arm (2), adjusting bolt (3) (early type, 100-125 cc)

5. Remove the countershaft sprocket bolts, disconnect the chain, remove the sprocket locking plate, and pull off the sprocket.

6. Refer to "Component Inspection," following.

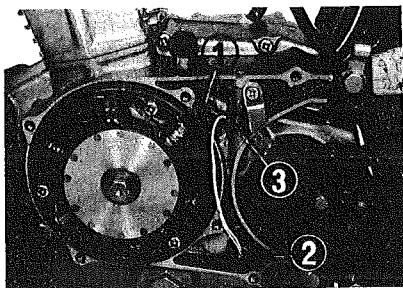

Alternator wiring grommet (1) and neutral switch wire routing

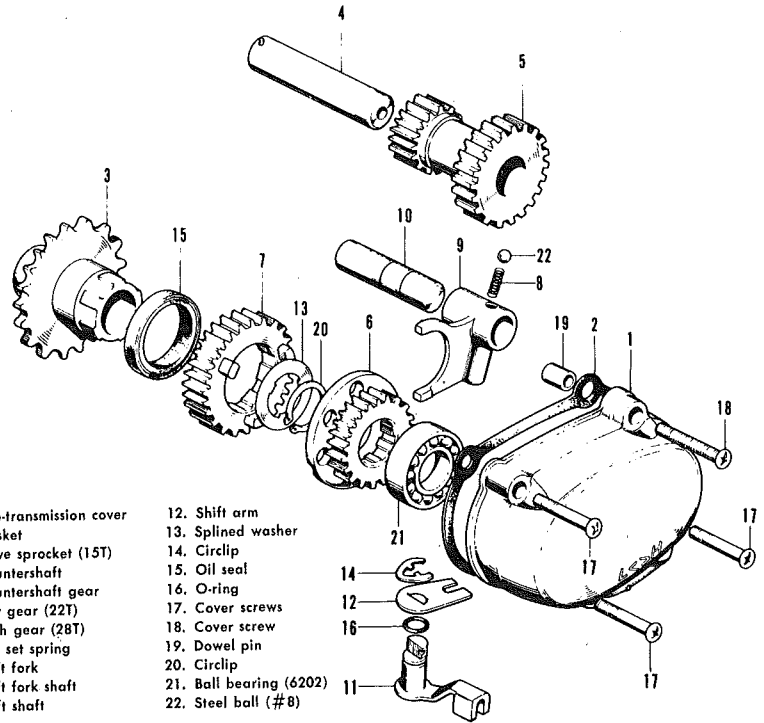

- | | |
|---------------------------|-------------------------|
| 1. Sub-transmission cover | 12. Shift arm |
| 2. Gasket | 13. Splined washer |
| 3. Drive sprocket (15T) | 14. Circlip |
| 4. Countershaft | 15. Oil seal |
| 5. Countershaft gear | 16. O-ring |
| 6. Low gear (22T) | 17. Cover screws |
| 7. High gear (28T) | 18. Cover screw |
| 8. Ball set spring | 19. Dowel pin |
| 9. Shift fork | 20. Circlip |
| 10. Shift fork shaft | 21. Ball bearing (6202) |
| 11. Shift shaft | 22. Steel ball (#8) |

Sub-transmission components (CT90)

7. Installation is the reverse of the above. Be sure that the O-ring is installed around the alternator stator. Be sure that the alternator wiring is correctly routed before installing the cover.

2. Remove the rotor cover. Remove the gearshift lever.

3. CT90: Remove the sub-transmission cover. Remove the sub-transmission Low gear, counter gear and shaft, shift fork and shaft. Remove the circlip, splined washer, and sub-trans High gear.

4. Other models: Remove the countershaft sprocket cover.

5. All: Remove the left crankcase cover.

6. Remove the screws which secure the alternator stator.

90 cc Models

REMOVAL AND INSTALLATION

1. Drain the oil. Disconnect the alternator wiring at the connector. Disconnect the neutral switch wire, if fitted.

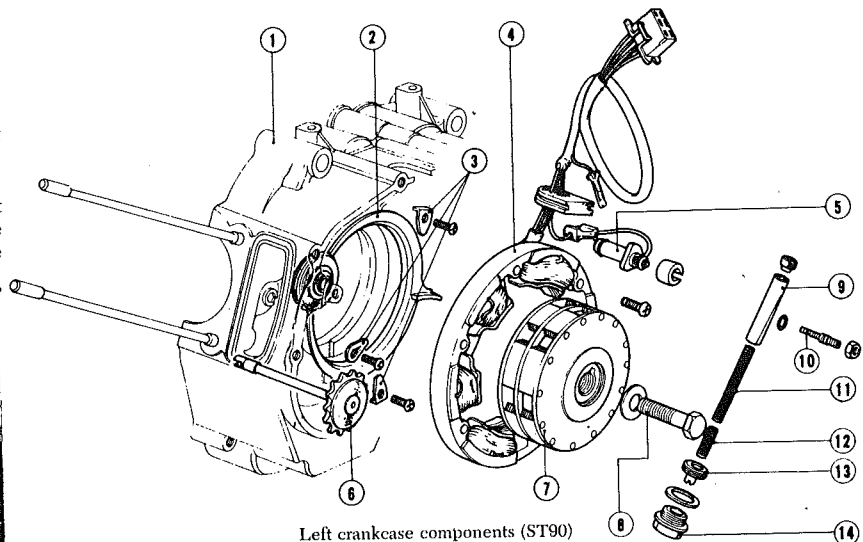

- | | |
|---------------------------|---------------------------------|
| 1. Left crankcase half | 8. Rotor bolt |
| 2. Cam chain tensioner | 9. Tensioner pushrod |
| 3. Retaining plates | 10. Adjusting bolt |
| 4. Alternator stator | 11. Tensioner spring, main |
| 5. Neutral switch | 12. Tensioner spring, secondary |
| 6. Cam chain guide roller | 13. Tensioner bolt |
| 7. Alternator rotor | 14. Cover bolt |

Left crankcase components (ST90)

7. Remove the alternator rotor bolt. Using the special tool, remove the rotor.

8. Back off the cam chain tensioner adjusting screw. Remove the tensioner cover bolt. Remove the tensioner bolt, spring and pushrod.

9. Remove the tensioner sprocket.

10. To remove the tensioner and roller, the top end assembly must be removed. Refer to that section. Remove the cam chain, then the three screws which hold the tensioner retaining plates.

11. Remove the countershaft sprocket bolts, disconnect the chain; remove the sprocket locking plate, and pull off the sprocket. CT90: The sprocket can be removed after disconnecting the chain.

12. Refer to "Component Inspection," following.

13. Installation is the reverse of the above.

50-70cc Models

REMOVAL AND INSTALLATION

1. Drain the oil. Disconnect the alternator or magneto wiring at the connector. Disconnect the neutral switch wire, if fitted. Remove the gearshift lever.

2. Remove the rotor nut. Using the special puller, remove the rotor.

3. Remove the rotor nut. Using the special puller, remove the rotor.

4. Remove the two screws which secure the coil stator plate. Tap the plate lightly to rotate it, then remove it.

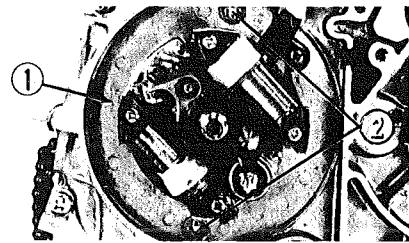

Magneto stator plate (1) and securing screws (2) (50-70 cc)

5. Back off the tensioner adjusting screw. Remove the tensioner cover bolt. Remove the tensioner bolt, spring, and pushrod.

6. Remove the tensioner arm pivot bolt, and the arm and roller.

7. Remove the countershaft sprocket bolts, disconnect the chain, remove the sprocket locking plate, and pull off the sprocket.

NOTE: On models with a full-coverage chain guard, wire the ends of the chain together to keep them from falling into the chaincase.

8. Refer to "Component Inspection," following.

9. Installation is the reverse of the above. Note that the O-rings in the stator plate screw holes, the plate O-ring and the crankshaft oil seal must be in place.

Component Inspection

NOTE: Where necessary, refer to the specifications charts at the end of this section for wear limits and tolerances.

CLUTCH

Clutch component inspection proce-

dures are outlined in "Engine Rebuilding." Specifications for individual models are given in the charts at the end of this section.

GEARSHIFT LINKAGE

Note those procedures applicable to the type of shift linkage fitted to your model.

1. Check the splines on the gearshift shaft. If the splines are broken or torn to such an extent that it is difficult to properly secure the shift lever, replace the shaft.

2. 50-90 cc: Check the condition of the shift arm. Be sure that it is not bent. Check that the shift fingers are not bent or worn.

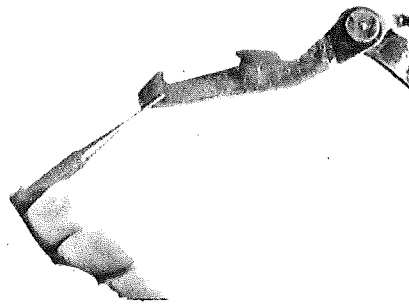

Check the shift arm fingers for damage

3. Check the condition of the springs in the shift linkage, especially the shift lever return spring. If any spring has lost its tension, or fails to hold its component properly, replace it.

4. 100-125 cc: Check the inner surfaces of the shift plate for wear caused by contact with the shift drum stopper plate pins. Replace the shift plate or stopper plate if wear is evident.

5. Check the condition of the shift drum stopper roller and replace it if worn. The stopper spring should hold the stopper firmly against the stopper plate.

6. Check the shift drum stopper plate and pins for wear. Replace if damaged.

KICK-STARTER

50-70 cc Models

1. Check the splines on the kick-starter shaft and replace the shaft if they are torn or will not secure the starter lever properly.

2. Check that the return spring retainer is not chipped and that its splines are not damaged.

3. The kick-starter return spring must be able to return the kick-starter lever to its stop and hold it there. If weakened or broken, replace it.

Other kick-starter components are accessible only after splitting the crankcases. Refer to that section.

OIL PUMP

Test procedures can be found in the "Lubrication Systems" section. When installing the pump or related parts, new

O-rings and gaskets should always be used.

ALTERNATOR

1. For electrical tests, refer to the "Electrical Systems" section.

2. Check the rotor and stator for signs of wear. If there has been contact between the rotor and the stator assembly, this condition must be rectified. In addition, the components should be tested to make sure that they still operate properly. Check the stator for foreign matter on the poles, burnt wiring, damaged insulation, etc.

3. Check that the stator assembly is securely mounted, and properly aligned. If the rotor has contacted the stator, check for play in the crankshaft. This condition may sometimes be caused by a bad crank bearing.

4. Remove any rust or corrosion from the crankshaft taper. Check the woodruff key for step-wear.

5. Check that the rotor has little or no run-out as it turns. If run-out exists, determine the cause.

6. If scoring on either the rotor or the stator components is severe, the part(s) should be replaced.

MAGNETO

1. For electrical tests, refer to the "Electrical Systems" section.

2. Check the inside of the rotor and the coil core ends for scoring which would indicate that they have been in contact. This condition must be rectified.

3. Check that the coils are securely mounted to the stator plate. Check that the plate is securely mounted. If the stator coils and rotor have been in contact, check for play in the crankshaft. This condition is sometimes caused by a bad crank bearing.

4. Check the rotor for cracks, especially on the tapered mount. Check that the timing advance mechanism (if fitted) functions properly. When the breaker cam is turned, the springs should have enough tension to return it to its original position easily.

5. Check the coils for broken or burned wiring, bad insulation, etc.

COUNTERSHAFT SPROCKET

1. Check the teeth of the sprocket and ensure that they are not hook-shaped, broken, or worn. If any wear is in evidence, the sprocket should be replaced, and the chain and rear wheel sprocket closely inspected for condition.

2. Check the rotational play of the sprocket on the countershaft. The sprocket splines should not show signs of wear. Replace the sprocket if it is not a firm fit on the shaft.

CRANKCASE COVERS

1. Always use new crankcase cover gaskets where they are fitted.

2. Remove any nicks or imperfections from the mating surfaces with an oilstone or silicon carbide paper.

3. Oil seals, where fitted, can be pried out. When fitting new seals, press them in with a block of wood or something similar which will cover the whole seal.

Honda 4-Stroke Singles

Press seals straight in until seated. Grease the seal lips before installation.

4. On some models, clutch lifter levers are fitted into the right crankcase cover. The levers can be pulled out after removing the pin which secures them to check the O-ring and spring.

5. Crankcase covers may be fitted with one or more hollow locating pins. These must be installed before the cover is fitted.

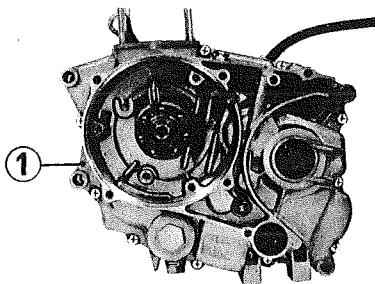

Crankcase screws (100-125 cc)

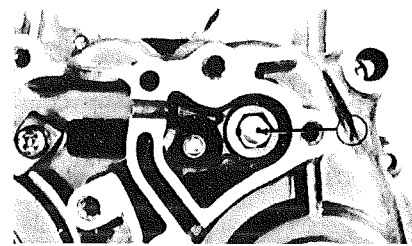

Gearshift drum bolt (1) (90 cc)

SUB-TRANSMISSION (CT90)

1. Check the condition of all the gear teeth for wear, pitting, or cracks. Pay close attention to the base of each tooth, since this is where most damage shows up.

2. Check the engaging dogs on the sub-trans High gear for wear or chipping. Inspect the corresponding holes in the Low gear as well.

3. Check the splines on the gears and the countershaft sprocket for wear or damage.

4. Check the condition of the shift fork fingers. They should be straight and the tips must be undamaged. To remove the shift fork shaft, pull it out. Note the steel ball and spring which locates the fork on the shaft.

Check the shaft for wear or discoloration. Be sure that the bore of the fork is without score marks.

To install the shaft into the fork, insert the spring and ball, and use a thin screwdriver through the hole in the fork to push down the ball so that the shaft can be inserted.

5. Check the condition of the countershaft ball bearing. Rotation of the bearing must be smooth and without binding. If necessary to remove the bearing, heat the cover slightly and tap out the bearing.

6. If leakage is noted from the sub-trans shift lever, remove the securing clip on the inside of the cover, and pull out the shift lever. Replace the O-ring on the shift lever shaft.

7. Installation is the reverse of removal. Use a new cover gasket. Be sure that the locating pin is in place for the upper right-hand cover screw. Note that this screw is threaded for its entire length.

NOTE: If the cases are stuck, they may be freed by tapping very gently with a plastic mallet. Do not strike the crankshaft or transmission shafts.

3. Remove the case gasket. Exercising care, tap the crankshaft out of the case. The case may be heated slightly with a propane torch in the vicinity of the crankshaft bearing boss to facilitate removal.

4. Carefully remove the gear clusters and shift drum assembly as a unit.

5. Pull out the kick-starter shaft and gears.

6. Refer to inspection procedures following.

90CC MODELS

1. Remove the engine from the frame. Remove the cylinder head, cylinder, and piston. Remove the left and right crankcase covers and remove the alternator stator and rotor, the countershaft sprocket, clutch, primary driven gear, gearshift shaft, cam chain, etc. Refer to the preceding sections for procedures. The oil pump need not be removed.

2. Remove the shift drum bolt on the left case half. Remove the screws in the right crankcase half. Tap around the mating surface with a plastic mallet and separate the case halves. Remove the case gasket.

The crankshaft and gear assemblies will remain in the left case half.

CAUTION: Do not strike the ends of the crank or transmission shafts to separate the cases.

3. Remove the kick-starter shaft from the right case half (new type) or left half (older type).

4. Remove the crankshaft from the left case half. The case may be heated gently with a propane torch in the vicinity of the bearing boss to facilitate removal.

5. Remove the gear clusters and shift drum.

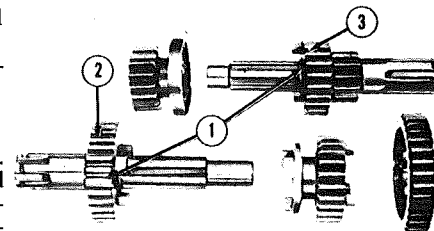

Transmission components (ST90): snap-ring (1); countershaft Third gear (2); mainshaft High gear

6. Refer to inspection procedures following.

50-70CC MODELS (EXCEPT XR75)

1. Remove the engine from the frame. Remove the cylinder head, cylinder, and piston. Remove the left and right-side covers and the components therein.

Refer to the preceding sections for procedures.

LOWER END AND TRANSMISSION

Splitting the Crankcases

100-125 CC MODELS

1. Remove the engine from the frame. Remove the cylinder head, cylinder, and piston. Remove the left and right-side covers and the components therein. Refer to the preceding sections for procedures.

2. Loosen the screws securing the crankcase halves (one screw is in the right case, the remaining 10 are in the left), with an impact driver. Remove the screws. Separate the case halves. The crank and transmission will remain in the right case half.

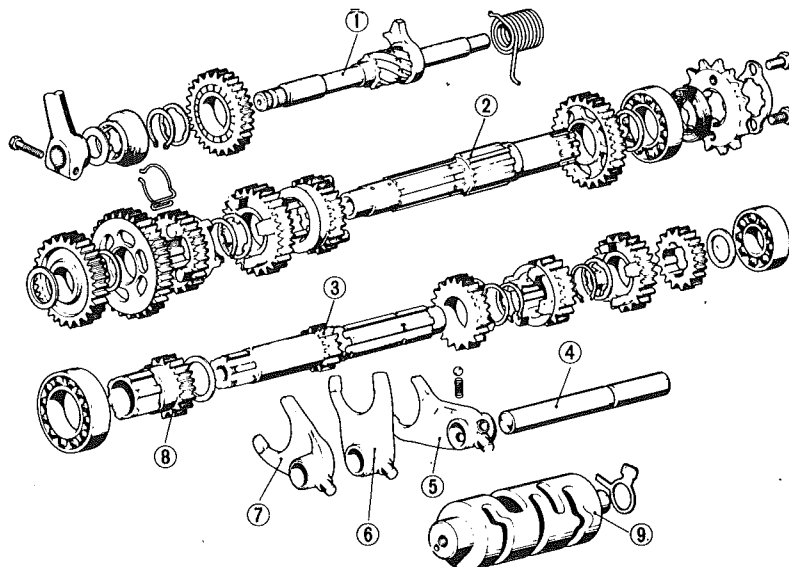

Gear clusters and shift drum assembly (100-125 cc)

- | | | |
|-----------------------|----------------------|----------------------|
| 1. Kick-starter shaft | 4. Shift fork shaft | 7. Right shift fork |
| 2. Countershaft | 5. Left shift fork | 8. Kick-starter gear |
| 3. Mainshaft | 6. Center shift fork | 9. Shift drum |

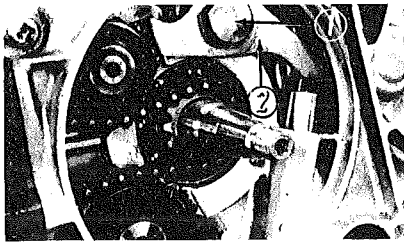

Tensioner arm pivot bolt (1) and arm (2) (50-70 cc)

2. Unscrew and remove the cam chain tensioner pushrod bolt, and remove the pushrod assembly. Remove the tensioner arm pivot bolt, and remove the arm and roller assembly.

3. Remove the shift drum bolt beneath the rubber plug on the left crankcase half. Remove the eight crankcase screws on the left case half.

The screws are of three different lengths. Note their location as they are removed.

4. Separate the cases. The crank and transmission will remain in the left half. **NOTE: If the cases are stuck, they may be freed by tapping very gently with a plastic mallet. Do not strike the crankshaft or transmission shafts.**

5. Remove the case gasket. Pull out the kick-starter shaft assembly.

6. With care, tap the crankshaft out of the case. The case may be heated slightly with a propane torch in the vicinity of the crankshaft bearing boss to facilitate removal.

7. Very carefully remove the gear clusters and shift drum assembly as a unit.

8. Refer to the inspection procedures following.

XR75

1. Remove the engine from the frame.

2. Remove the top end assembly: cylinder head, cylinder, and piston.

3. Remove the oil filter rotor and the oil pump. Remove the clutch, gearshift linkage, stopper arm and plate, magneto, and countershaft sprocket.

Refer to the preceding sections for procedures.

4. Remove the two phillips screws at the upper left and lower right of the right crankcase half.

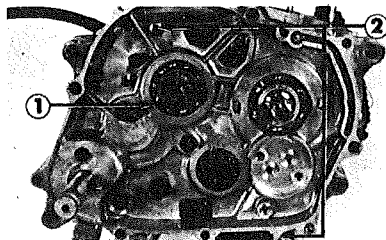

Right crankcase half (1) and securing screws (2) (XR75)

5. Split the cases by tapping around the mating surface with a plastic mallet. The crankshaft and gear clusters will remain in the left crankcase half.

6. Detach the kick-starter return

spring from the crankcase and pull out the kick-starter shaft assembly.

7. Remove the cam chain from the crank sprocket and take out the crankshaft. The left case may be heated slightly with a propane torch in the vicinity of the crankshaft bearing boss to facilitate removal.

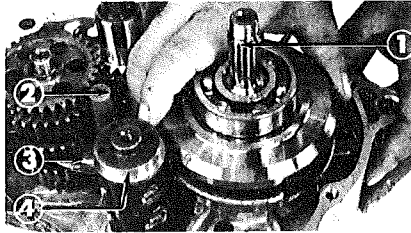

Crankshaft (1), shift fork shaft (2), shift fork (3), and shift drum (4)

8. Remove the shift fork shaft and the two shift forks. Remove the shift drum.

9. Remove the main- and countershafts and their gears as a unit.

10. Refer to the inspection procedures following.

Transmission

Inspection procedures for the transmission are outlined in "Engine Rebuilding."

Kick-Start

1. Check the splines on the kick-starter shaft and replace the shaft if they are damaged to the extent that they will not secure the kick-starter lever properly.

2. If the kick-starter gear has a plain bore, check that it is not galled or worn. If the gear has a splined bore, check that the splines are in good condition, and that the gear does not have excessive backlash on its shaft.

3. Check the condition of the gear teeth. On models with the ratchet-type kick-starter, the teeth on the side of the kick-starter gear are critical. If chipped or worn, the gear should be replaced.

4. Check the condition of the teeth on the ratchet gear and replace the gear if they are worn.

5. Check that the gear splines on the kick-starter shaft (where fitted) are in good condition. Check that the kick-starter shaft stopper or spring retainer and the stopper on the crankcase are not worn or chipped. If a stopper bolt is fitted, be sure that it is firmly secured in the case.

6. Check that the kick-starter shaft return spring is able to hold the kick-starter lever firmly in place. If the lever fails to return to its proper position, replace the return spring.

7. Check the retainer spring fitted to ratchet-type starters and replace it if bent or otherwise damaged.

Crankshaft

The crankshaft is a pressed-together unit. The connecting rod big end bearing is the caged-needle type. In the event of damage to the con rod, bearing or crankpin, the crankshaft must be replaced as an assembly.

1. Lubricate the big end bearing with oil, and rotate the rod slowly around the

crankpin. The movement must be smooth and silent.

2. With a dial gauge, check the up-and-down (radial) movement of the con rod. Compare the reading with the specification given. If rod movement is in excess of the specifications, the big end bearing is worn and the crankshaft must be replaced.

3. With a feeler gauge, check the clearance between the con rod big end and the crankshaft flywheel. Compare the measurement with the specification given for axial clearance.

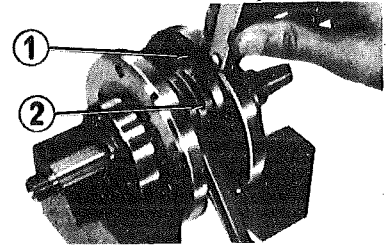

Checking big end side clearance (2) with a feeler gauge (1)

4. Place the crankshaft on a set of V-blocks, and check the crankshaft run-out with a dial gauge. Check both ends of the crank. Compare the run-out reading with the specification given for your model. If excessive, the crank must be replaced.

Crankshaft run-out will be one half of the true indicated reading of the gauge.

Crankcases

1. Check for damage to the bearing bosses, especially for stress cracks around the bearing boss.

2. Be sure that both case half mating surfaces are free of any traces of old gasket or gasket material.

3. Place each case half on a flat surface and check for warpage by probing around the mating surface with a feeler gauge. Maximum acceptable case warpage is 0.05 mm (0.002 in.). If warped, cases should be replaced.

4. Minor scratches on the mating surfaces can be removed with an oilstone, although it is not permissible to remove much metal.

5. Case halves must be scrupulously clean before assembly. Be sure that all oil passages are clear and that any dowel pins fitted between the case halves are installed.

Crankcase Assembly

100-125 CC MODELS

1. Assemble the shift drum mechanism if it was disassembled. The left gearshift fork is secured by a spring-loaded ball. To install, insert the spring and the ball into the shift fork, push the ball down with a thin screwdriver, and slip in the shaft.

2. Install the components into the case in the reverse of the removal procedure. Note the following points:

a. Install the crankshaft into the case by pushing it straight in until the bearing is seated. Do not strike the end of the crankshaft to install it;

Honda 4-Stroke Singles

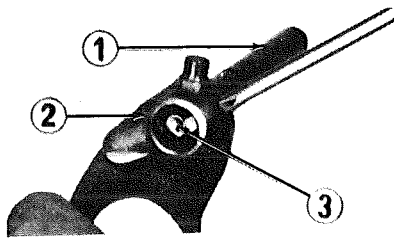

Installing the shift fork shaft (1) in the fork (2) by compressing the ball and spring (3) with a thin Phillips screwdriver (100-125 cc)

b. Install the gear clusters first, then the shift drum. Position the shift drum so that the neutral switch rotor would be parallel with the cylinder. This is equivalent to Neutral. Noting the locating marks on the shift forks, install the right, center, and left forks, in that order, engaging the cam follower pin of each fork with the proper groove in the shift drum. Then install the shift fork shaft;

c. Install the kick-starter shaft. Be sure that the return spring is seated in the crankcase. The retainer spring must protrude through the hole in the crankcase as illustrated;

d. Lubricate all bearings with motor oil;

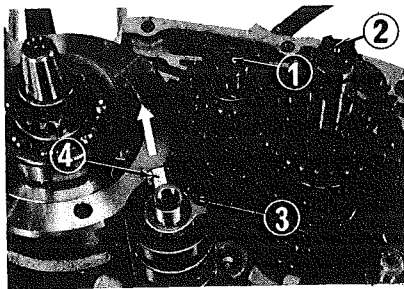

The neutral switch rotor (4) on the shift drum (3) should be parallel with the cylinder (about 10° from vertical) when installing the shift forks (100-125 cc)

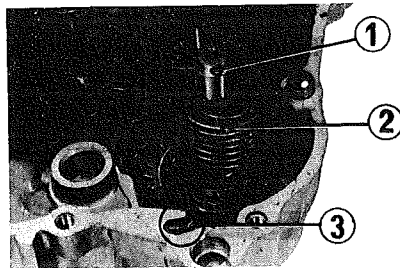

When installing the kick-starter assembly (1), be sure that the end of the return spring (2), is fitted into the cutout in the case (3)

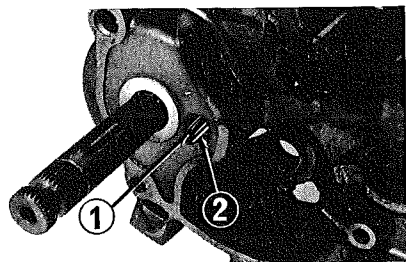

The end of the retainer spring protrudes through the hole in the case

1. Mainshaft
2. Countershaft
3. Countershaft low gear (35T)
4. Mainshaft second gear (17T)
5. Countershaft second gear (31T)
6. Mainshaft high gear (21T)
7. Countershaft high gear
8. Countershaft sprocket
9. Sprocket lockplate

10. Gear sleeve
11. Sprocket bolts
12. Thrust washer
13. Thrust washer
14. Splined washer
15. Circlip
16. Countershaft oil seal
17. Ball bearing (6203)

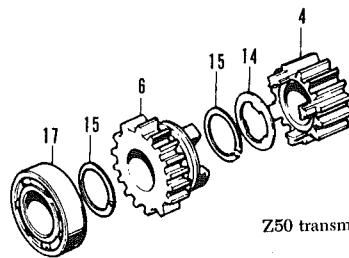
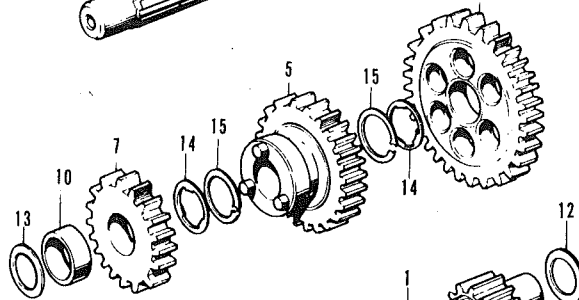
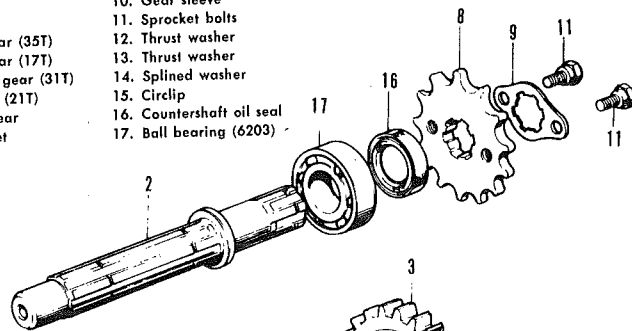

Z50 transmission components

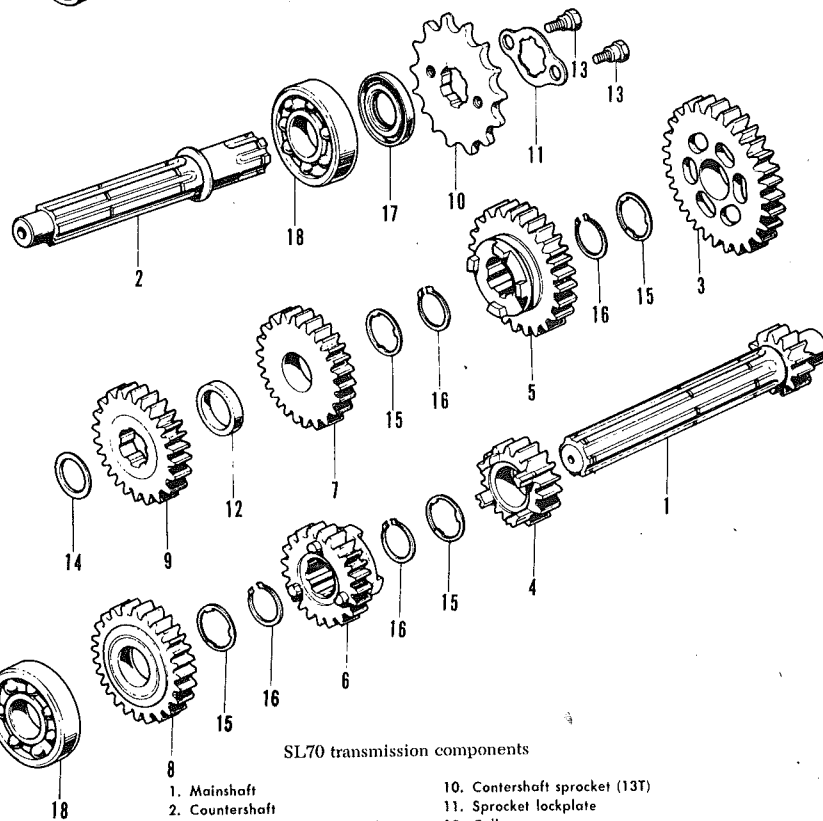

SL70 transmission components

1. Mainshaft
2. Countershaft
3. Countershaft low gear (35T)
4. Mainshaft second gear (17T)
5. Countershaft second gear (31T)
6. Mainshaft third gear
7. Countershaft third gear (26T)
8. Mainshaft high gear (24T)
9. Countershaft high gear (23T)

10. Countershaft sprocket (13T)
11. Sprocket lockplate
12. Collar
13. Sprocket bolts
14. Thrust washer
15. Splined washer
16. Circlip
17. Oil seal
18. Ball bearing (6203)

Honda 4-Stroke Singles

Engine and Transmission Specifications

125 cc Models (1975 and Earlier)

		Standard mm (in.)	Serviceable Limit mm (in.)
ENGINE			
Cylinder bore diameter (standard)		56.00-56.01 (2.2047-2.2051)	56.10 (2.2086)
Piston OD (standard)		55.74-55.76 (2.1945-2.1953)	55.65 (2.1810)
Piston-cylinder clearance		0.025-0.05 (0.001-0.002)	0.1 (0.004)
Wrist pin hole ID		15.002-15.008 (0.5906-0.5909)	15.04 (0.5921)
Wrist pin OD		14.994-15.000 (0.5903-0.5906)	14.96 (0.5890)
Piston ring side clearance	Top	0.025-0.055 (0.0010-0.0022)	0.09 (0.0035)
	2nd	0.015-0.045 (0.0006-0.0018)	0.09 (0.0035)
Piston ring end-gap	Top	0.15-0.35 (0.0059-0.0138)	0.5 (0.0197)
	2nd	0.15-0.35 (0.0059-0.0138)	0.5 (0.0197)
	Oil	0.30-0.90 (0.0118-0.0354)	—
Connecting rod big end bearing clearance		0-0.008 (0-0.0003)	0.05 (0.0020)
Connecting rod big end side clearance		0.05-0.30 (0.0020-0.0118)	0.8 (0.0315)
Crankshaft run-out	Left-side	0.02 (0.0008) max	0.05 (0.0020)
	Right-side	0.015 (0.0006) max	0.05 (0.0020)
Rocker arm-to-shaft clearance		0.916-0.052 (0.0006-0.0021)	0.08 (0.0032)
Cam height	In	31.906 (1.2561)	31.776 (1.2510)
	Ex	31.496 (1.2400)	31.366 (1.2349)
Valve stem OD	In	5.450-5.465 (0.2146-0.2175)	5.41 (0.2130)
	Ex	5.430-5.445 (0.2138-0.2167)	5.39 (0.2122)
Valve stem-to-guide clearance	In	0.01-0.035 (0.0004-0.0014)	0.12 (0.0047)
	Ex	0.03-0.055 (0.0012-0.0022)	0.14 (0.0055)
Valve seat width		0.7 (0.028)	1.5 (0.059)
Valve spring free-length	Inner	36.55 (1.4390)	33.2 (1.3071)
	Outer	41.6 (1.6378)	37.5 (1.4764)
TRANSMISSION			
Clutch friction disc thickness		2.9-3.0 (0.1142-0.1181)	2.6 (0.1024)
Clutch plate warpage		0.1 (0.0039) max	0.2 (0.0079)
Clutch spring free-length		35.5 (1.3976)	32 (1.260)
Shift fork ID		12.000-12.018 (0.4724-0.4732)	12.05 (0.4744)
Shift fork shaft OD		11.976-11.994 (0.4715-0.4722)	11.96 (0.4709)
Shift fork finger width		4.93-5.00 (0.1941-0.1969)	4.7 (0.1859)
Kick-starter gear ID		24.900-24.921 (0.9803-0.9811)	24.94 (0.9819)
Transmission gear backlash		NA	0.2 (0.008)

e. Fit a new gasket. Ensuring that the transmission is in Neutral, assemble the case halves. Do not force the cases together. Install the crankcase screws and tighten them in a cross pattern, to about 8 ft lbs;

NOTE: Do not use the screws to mate the cases. This should be accomplished before they are tightened.

f. Check for free rotation of the crankshaft and the gears, and operation of the kick-starter and shifter.

90cc MODELS

1. Assemble the shift drum mechanism if it was disassembled. Slide the forks onto the shift drum, install the pins, and fit the securing clips.

2. Assemble the shift drum assembly and the gear clusters and insert them into the left crankcase half. On newer models, the kick-starter shaft is inserted into the right crankcase half, the left half on older machines.

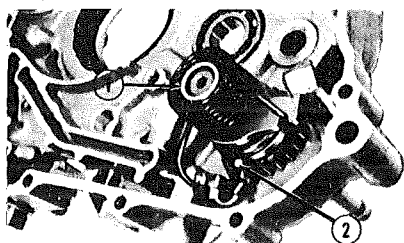

Kick-starter components (late models, 90 cc)

3. Install the crankshaft in the left case half, after heating the case as on removal. Do not strike the crankshaft to seat the bearing.

4. Lubricate all interior components with motor oil.

5. Be sure that the mating surface dowel pins are in place. Fit a new gasket. Mate the case halves. Do not force or strike the cases to bring them together.

6. Fit the case screws and the shift drum bolt.

7. Check for smooth rotation of the crank and correct operation of the shifter mechanism.

50-70CC MODELS (EXCEPT XR75)

1. Assemble the shift drum mechanism if it was disassembled. Slide the forks onto the shift drum, install the pins, and fit the securing clips.

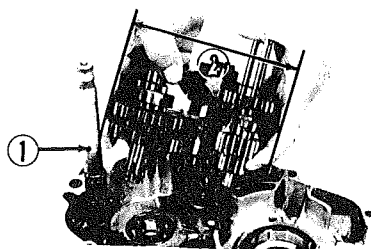

Installing the gear clusters (50-70 cc)

2. Assemble the shift drum assembly and the gear clusters and insert them into the left crankcase half. Insert the kick-starter assembly.

3. Install the crankshaft in the left case half, after heating the case as on removal.

Honda 4-Stroke Singles

Do not strike the crankshaft to seat the bearing.

4. Lubricate all interior components with motor oil.

5. Be sure that the mating surface dowel pins are in place. Fit a new gasket. Mate the case halves. Do not force or strike the cases to bring them together.

6. Fit the case screws. Note that the case screws are of different lengths. Tighten the case screws in a cross pattern to about 8 ft lbs. Do not tighten the screws unless the cases are mated. Do not use the screws to mate the cases.

7. Hold the shift drum against the case and install the shift drum bolt.

8. Check for smooth rotation of the crank and proper operation of the shift mechanism and kick-starter.

XR75

1. Install the gear clusters together in the left crankcase half.

2. Install the shift drum insuring that the neutral switch rotor on the drum points toward the neutral switch on the case.

3. Install the center gearshift fork, engaging it first with the mainshaft Third gear and then with the groove in the shift drum.

4. Install the right gearshift fork engaging it with the countershaft Second gear and the shift drum. Install the shift fork shaft. Check gear rotation.

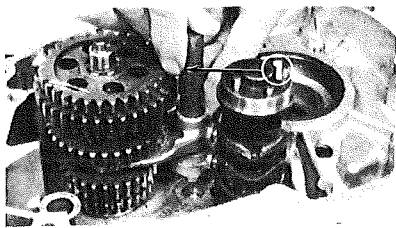

Installing the shift fork shaft (1) (XR75)

5. Install the kick-starter shaft, engaging the end of the return spring with the crankcase lug. Install the kick-starter pedal onto the shaft, and use it to rotate the shaft until the kick-starter spring retainer can be pushed down into the recess in the case.

6. Loop the cam chain through the cutout in the left case, then install the crankshaft. The case bearing boss may be heated slightly as on removal to facilitate installation of the crank.

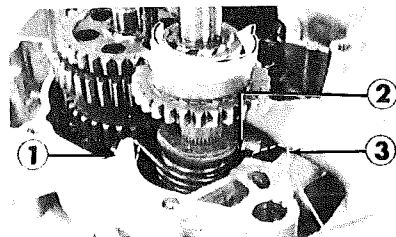

Rotate the shaft as shown until the spring retainer (2) can be pushed down into the recess (3). The other end of the return spring must be engaged as shown (1).

7. Lubricate all interior components with motor oil.

125 cc Models (1976) ①

		Standard mm (in.)	Serviceable Limit mm (in.)
ENGINE			
Cylinder bore diameter (standard)		56.50-56.51 (2.2244-2.2247)	56.60 (2.2283)
Piston OD (standard)		56.46-56.48 (2.2228-2.2236)	56.35 (2.2184)
Crankshaft run-out Left and right sides		0.02 (0.0008)	0.05 (0.0020)
Valve spring free-length	Inner	39.2 (1.5433)	35.2 (1.3858)
	Outer	44.85 (1.7658)	40.5 (1.5945)

① For all other 1976 engine specifications, refer to "125 CC Models (1975 and Earlier)."

100 cc Models

ENGINE			
Cylinder bore diameter (standard)		50.50-50.51 (1.9881-1.9885)	50.56 (1.9906)
Piston OD (standard)		50.47-50.49 (1.9870-1.9878)	50.38 (1.9835)
Piston-cylinder clearance		0.025-0.05 (0.001-0.002)	0.1 (0.004)
Wrist pin hole ID		14.002-14.008 (0.5513-0.5515)	14.04 (0.5528)
Wrist pin OD		13.994-14.000 (0.5509-0.5512)	13.96 (0.5496)
Piston ring side clearance	Top	0.015-0.045 (0.0006-0.0018)	0.09 (0.0035)
	2nd	0.015-0.045 (0.0006-0.0018)	0.09 (0.0035)
	Oil	0.015-0.045 (0.0006-0.0018)	0.09 (0.0035)
Piston ring end-gap	Top	0.15-0.35 (0.0059-0.0138)	0.5 (0.0197)
	2nd	0.15-0.35 (0.0059-0.0138)	0.5 (0.0197)
	Oil	0.15-0.35 (0.0059-0.0138)	0.5 (0.0197)
Connecting rod big end bearing clearance		0-0.008 (0-0.0003)	0.05 (0.0020)
Connecting rod big end side clearance		0.05-0.30 (0.0020-0.0118)	0.8 (0.0315)
Crankshaft run-out	Left-side	0.02 (0.0008) max	0.05 (0.0020)
	Right-side	0.015 (0.0006) max	0.05 (0.0020)
Rocker arm-to-shaft clearance		0.016-0.052 (0.0006-0.0021)	0.08 (0.0032)
Cam height	In	31.903-32.063 (1.2560-1.2623)	31.853 (1.2541)
	Ex	31.039-31.199 (1.2220-1.2273)	30.989 (1.2200)
Valve stem OD	In	5.450-5.465 (0.2146-0.2175)	5.41 (0.2130)
	Ex	5.430-5.445 (0.2138-0.2167)	5.39 (0.2122)
Valve stem-to-guide clearance	In	0.01-0.035 (0.0004-0.0014)	0.12 (0.0047)
	Ex	0.03-0.055 (0.0012-0.0022)	0.14 (0.0055)
Valve seat width		0.75 (0.0295)	1.5 (0.059)
Valve spring free-length	Inner	33.5 (1.3189)	30.2 (1.1890)
	Outer	40.9 (1.6102)	36.8 (1.4488)

Honda 4-Stroke Singles

8. Install the two dowel pins on the case mating surface, fit a new gasket and install the other case half.

9. Be sure that the cases are mated all the way around (do not force the cases together), then install and tighten the two case screws.

10. Check for smooth crankshaft rotation and for proper operation of the shifter and kick-starter.

NOTE: When mating the cases, be sure that each shaft and the end of the kick-starter retainer spring enter their holes in the right case.

Engine Torque Specifications 100-125 cc Models

Part	Torque (ft lbs)
Cylinder head	11.5-14.5
Spark advance mechanism bolt	5.8-8.7
Cam sprocket	5.8-8.7
Cylinder mounting bolt	8.7-13.0
Alternator rotor	18.8-23.2
Alternator stator	5.8-8.7
Crankcase cover screws	5.8-8.7
Cam chain tensioner arm	5.8-8.7
Oil filter rotor	29.0-36.0
Oil pump gear cover	2.9-4.4
Oil pump body	5.6-8.7
Clutch spring bolts	5.6-8.7
Gearshift drum stopper bolt	5.6-8.7
Gearshift drum stopper plate	5.6-8.7

50-90 cc Models

Crankcase screws	5.8-8.0
Cylinder head stud nut	6.5-8.7
Cylinder side bolt	5.8-8.0
Cylinder head side bolt	7.4-10.8
Camshaft sprocket bolts	3.6-6.5
Cylinder head right-side cover	5.1-6.5
Cylinder head left-side cover	5.8-8.7
Valve adjuster locknut	5.1-7.2
Cam chain tensioner pushrod	10.8-18.1
Oil pump	5.8-8.7
Shift drum bolt	6.5-10.8
Shift drum stopper plate	6.5-9.4
Shift drum stopper	7.2-11.6
Clutch hub nut	27.5-32.5
Right crankcase cover	5.8-8.7
Left crankcase cover	5.8-8.0
Alternator/magneto rotor	23.9-27.5
Countershaft sprocket	6.5-10.8
Oil drain bolt	18.1-25.3
Carburetor	6.5-10.1
Spark plug	8.0-10.8

XR75

Crankcase screws	5.1-8.7
Crankcase cover screws	5.1-8.7
Cylinder head cover	5.8-8.7
Camshaft holder	5.8-8.7
Camshaft sprocket	7.3-11.6
Carburetor manifold	5.8-8.7
Magneto rotor	21.7-27.5
Oil filter rotor	25.3-32.6
Tappet adjuster locknut	5.1-8.0
Engine drain plug	14.5-21.7

General Torque Specifications ①

Part	Torque (ft lbs)
5 mm machine screws	2.2-2.9
6 mm machine screws	5.0-7.2
6 mm hex bolts	5.8-8.7
8 mm hex bolts	13.0-18.1
10 mm hex bolts	21.7-28.9
6 mm flange bolts	7.2-10.1
8 mm flange bolts	17.4-21.7
10 mm flange bolts	21.7-28.9

① Unless otherwise specified

100 cc Models

	Standard mm (in.)	Serviceable Limit mm (in.)
TRANSMISSION		
Clutch friction disc thickness	2.9-3.0 (0.1142-0.1181)	2.6 (0.1024)
Clutch plate warpage	0.1 (0.0039) max	0.2 (0.0079)
Clutch spring free-length	35.5 (1.3976)	32 (1.260)
Shift fork ID	12.000-12.018 (0.4724-0.4732)	12.05 (0.4744)
Shift fork shaft OD	11.976-11.994 (0.4715-0.4722)	11.96 (0.4709)
Shift fork width	4.93-5.00 (0.1941-0.1969)	4.7 (0.1859)
Kick-starter gear ID	24.900-24.921 (0.9808-0.9811)	24.94 (0.9819)
Transmission gear backlash	—	0.2 (0.008)

90 cc Models

ENGINE		
Cylinder bore diameter (standard)	50.0-50.01 (1.9685-1.9689)	50.1 (1.9724)
Piston OD (standard)	49.97-49.99 (1.9674-1.9681)	49.9 (1.9646)
Piston-cylinder clearance	0.025-0.05 (0.001-0.002)	0.1 (0.004)
Wrist pin hole clearance	0.002-0.004 (0.0008-0.0006)	0.05 (0.002)
Piston ring side clearance	0.01-0.045 (0.0004-0.0018)	0.12 (0.0047)
Piston ring end-gap		
Compression rings	0.15-0.35 (0.0059-0.0139)	0.5 (0.020)
Oil ring	0.15-0.40 (0.0059-0.0158)	0.50 (0.020)
Connecting rod big end clearance	0-0.01 (0-0.0004)	0.05 (0.002)
Connecting rod big end side clearance	0.10-0.35 (0.0039-0.0138)	0.80 (0.0315)
Crankshaft run-out	0.03 (0.0012) max	0.10 (0.0039)
Rocker arm ID	10.00-10.02 (0.3937-0.3943)	10.1 (0.3976)
Rocker arm shaft OD	9.972-9.987 (0.3926-0.3932)	9.92 (0.3906)
Valve stem OD	In 5.455-5.465 (0.2148-0.2152)	5.435 (0.2140)
	Ex 5.435-5.445 (0.2140-0.2144)	5.415 (0.2133)
Valve stem-guide clearance	In 0.010-0.030 (0.0004-0.0012)	0.06 (0.0024)
	Ex 0.030-0.050 (0.0012-0.0020)	0.08 (0.0032)
Valve seat width	0.70-1.20 (0.0276-0.0472)	1.50 (0.059)
Valve guide ID	5.475-5.485 (0.2156-0.2160)	5.525 (0.2175)
Valve spring free-length	Inner 26.5 (1.0433)	25.5 (1.0039)
	Outer 31.8 (1.2520)	30.6 (1.2047)
TRANSMISSION		
Clutch friction disc thickness		
Manual clutch	2.8-2.9 (0.110-0.114)	2.4 (0.094)
Centrifugal clutch	2.65-2.75 (0.104-0.108)	2.25 (0.087)

Honda 4-Stroke Singles

LUBRICATION SYSTEM

OIL PUMP SERVICE

50-90 cc Models

1. Remove the right crankcase cover and clutch assembly as described in the "Engine and Transmission" chapter.

2. Remove the three mounting screws and/or bolt from the oil pump, and remove the oil pump assembly.

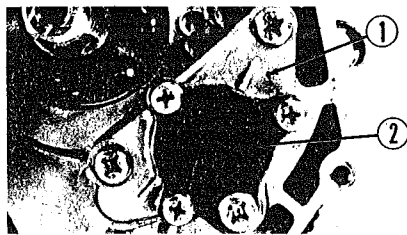

Oil pump (1) and cover (2) (50-90 cc)

3. Remove the cover screws and remove the cover. Remove the inner and outer rotors, and inspect for obvious damage.

4. Install the rotors and measure the clearance between the outer rotor and the oil pump body with a feeler gauge. Replace the pump if clearance is excessive.

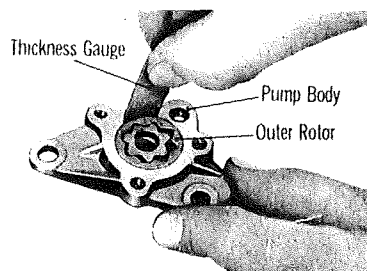

Measuring outer rotor-to-pump body clearance

5. Measure the rotor end-play by placing a straightedge across the cover surface with the gasket in place and measuring the clearance between the straightedge and the rotors with a feeler gauge.

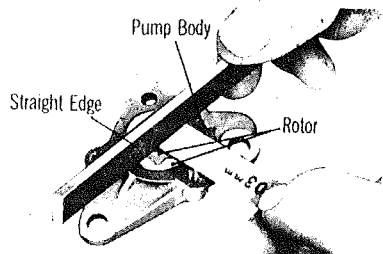

Checking rotor end-play

6. Measure the clearance between the rotors with a feeler gauge. Excessive clearance will cause excessive backlash

90 cc Models

	Standard mm (in.)	Serviceable Limit mm (in.)
TRANSMISSION		
Clutch plate warpage	0.10 (0.004) max	0.2 (0.008)
Clutch spring free-length Manual clutch	26.8 (1.0551)	25.8 (1.032)
Centrifugal clutch	27.0 (1.063)	26.0 (1.024)
Shift fork ID	42.0-42.025 (1.6535-1.6545)	42.065 (1.6561)
Shift drum OD	41.950-41.975 (1.6516-1.6522)	41.93 (1.6508)
Shift fork finger width	5.96-6.04 (0.2347-0.2378)	5.70 (0.2244)
Transmission gear backlash	0.084-0.170 (0.0033-0.0067)	0.25 (0.00984)

70 cc Models

ENGINE		
Cylinder bore diameter (standard)	47.00-47.01 (1.8504-1.8508)	47.1 (1.8540)
Piston OD (standard)	46.98-46.99 (1.8497-1.850)	46.9 (1.8465)
Piston-cylinder clearance	0.025-0.050 (0.001-0.002)	0.1 (0.004)
Piston ring side clearance		
Compression rings	0.015-0.045 (0.0006-0.0018)	0.1 (0.004)
Oil ring	0.010-0.045 (0.0004-0.0018)	0.1 (0.004)
Piston ring end-gap		
Compression rings	0.15-0.35 (0.006-0.014)	0.5 (0.020)
Oil ring	0.15-0.40 (0.006-0.016)	0.5 (0.020)
Valve seat width	1.0-1.3 (0.040-0.051)	2.0 (0.080)
Valve guide ID	5.475-5.485 (0.2156-0.2159)	5.525 (0.2175)
Valve stem OD	In 5.455-5.465 (0.2148-0.2187) Ex 5.435-5.445 (0.2070-0.2109)	5.40 (0.2126) 5.38 (0.2048)
Valve stem-guide clearance	In 0.01-0.03 (0.0004-0.0012) Ex 0.03-0.05 (0.0012-0.002)	0.08 (0.0032) 0.1 (0.004)
Valve spring free-length	Outer 28.1 (1.106) Inner 25.1 (0.988)	26.9 (1.059) 23.9 (0.941)
Connecting rod big end axial clearance	0.1-0.35 (0.004-0.0138)	0.8 (0.0315)
Connecting rod big end radial clearance	0.01-0.012 (0.0004-0.0005)	0.05 (0.002)
TRANSMISSION		
Clutch friction disc thickness	3.50 (0.138)	3.10 (0.122)
Clutch plate warpage	—	0.15 (0.006)
Clutch spring free-length		
Manual clutch	20.0 (0.79)	19.0 (0.75)
Centrifugal clutch	21.4 (0.84)	20.4 (0.80)

Honda 4-Stroke Singles

70 cc Models

and noisy pump operation. Replace the pump if clearance is excessive.

7. Assemble the pump using a new cover gasket. The gasket must not touch the rotors. Try to turn the pump by hand, it should turn freely with little resistance.

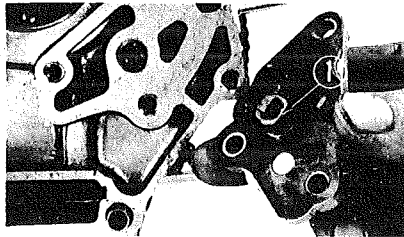

Be sure that the driving tab of the pump is properly fitted into its slot upon installation

8. Install the pump on the engine. Be sure to line up the tab on the pump drive with the slot in the pump driveshaft.

XR75, 100-125 cc Models

1. Drain the crankcase. Remove the exhaust system. Remove the kick-starter.

2. Disconnect the clutch cable from the right-side cover. Remove the skid plate and step bar (if fitted).

3. Remove the right crankcase cover.

4. Remove the oil filter rotor cover.

5. Using the special wrench, remove the rotor nut.

NOTE: To stop the crankshaft from turning, engage the transmission and apply the rear brake or use a block of wood jammed between the primary gear and the clutch gear.

6. Remove the oil pump gear cover.

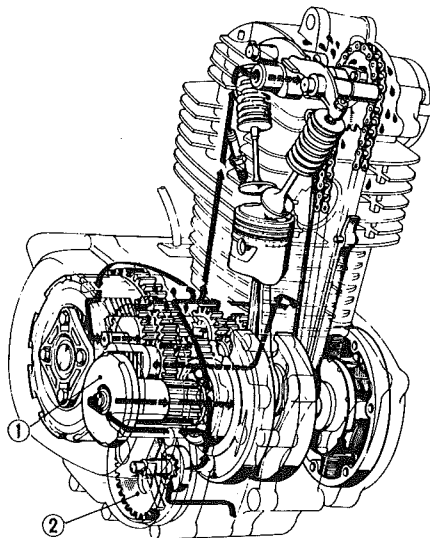

Lubrication system (100-125 cc)

7. Remove the oil pump drive gear and shaft. Note the thrust washer on the end of the shaft.

8. Remove the two pump mounting bolts and remove the oil pump.

9. Remove the two screws from the cover on the back of the oil pump, and remove the cover.

10. Remove the two rotors and inspect

TRANSMISSION

		Standard mm (in.)	Serviceable Limit mm (in.)
Shift drum diameter		33.95-33.98 (1.3366-1.3377)	33.9 (1.335)
Shift fork ID		34.0-34.03 (1.3385-1.3395)	34.2 (1.347)
Shift fork finger width	Right	5.5-6.3 (0.217-0.248)	5.3 (0.209)
	Left	4.5-5.3 (0.177-0.209)	4.3 (0.169)
Transmission gear backlash		0.09-0.18 (0.0035-0.0070)	0.25 (0.010)

XR75

ENGINE

Cam height	In	27.677-27.717 (1.0896-1.0972)	27.5 (1.0827)
	Ex	27.540-27.586 (1.0833-1.0861)	27.36 (1.0772)
Rocker arm-to-shaft clearance		0.013-0.037 (0.0005-0.0015)	0.1 (0.0039)
Valve seat width		1.0 (0.0394)	1.5 (0.0591)
Valve stem OD	In	5.450-5.465 (0.2146-0.2152)	5.42 (0.2134)
	Ex	5.430-5.445 (0.2138-0.2144)	5.40 (0.2126)
Valve-to-valve guide clearance	In	0.01-0.035 (0.0004-0.0014)	0.08 (0.0031)
	Ex	0.03-0.055 (0.0012-0.0022)	0.1 (0.0039)

XR75

ENGINE

Valve spring free-length	Inner	28.05 (1.1043)	27.0 (1.0630)
	Outer	33.8 (1.3307)	32.7 (1.2874)
Cylinder bore (standard)		47.0-47.01 (1.8504-1.8508)	47.1 (1.8543)
Piston OD (standard)		46.97-46.99 (1.8492-1.8500)	46.80 (1.8425)
Cylinder-piston clearance		0.025-0.050 (0.001-0.002)	0.1 (0.004)
Wrist pin hole diameter		13.002-13.008 (0.5119-0.5121)	13.06 (0.5142)
Wrist pin OD		12.994-13.00 (0.5116-0.5118)	12.9 (0.5079)
Piston ring side clearance	Compression	0.015-0.045 (0.0006-0.0018)	0.15 (0.0059)
	Oil	0	0.15 (0.0059)
Piston ring end-gap	Compression	0.15-0.35 (0.0059-0.0138)	0.5 (0.0197)
	Oil	0.3-0.9 (0.012-0.035)	0.5 (0.0197)

TRANSMISSION

Friction disc thickness		2.8-2.9 (0.1102-0.1142)	2.5 (0.0984)
Clutch plate warpage		0.1 (0.0039) max	0.2 (0.0079)
Clutch spring free-length		27.3 (1.0748)	25.3 (0.9961)
Cam chain guide wear		—	1.0 (0.0394)
Cam chain tensioner wear		—	1.0 (0.0394)

Honda 4-Stroke Singles

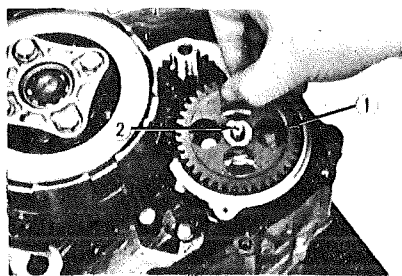

Removing the oil pump drive gear (1) and shaft (2) (100-125 cc and XR75)

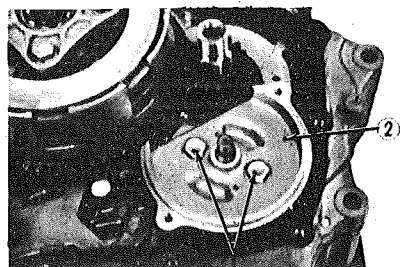

Pump (2) and mounting bolts (1)

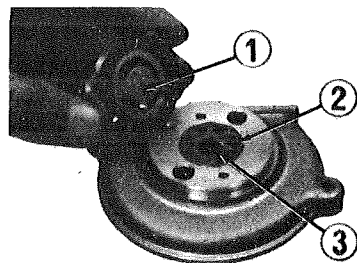

Pump cover (1), outer rotor (2), and inner rotor (3)

them for any obvious damage such as chipped teeth.

11. Check the outer rotor-to-pump body clearance and compare the reading with the proper specification. Replace the pump if clearance is excessive.

12. Check the inner rotor-to-outer rotor clearance, and compare the reading against the proper specification. Replace the pump if the clearance is excessive.

13. When installing the pump, always use a new pump gasket. Be sure that the gasket does not contact the rotor.

14. Install the two rotors, and replace the pump cover. Line up the lug on the cover with the notch of the pump body.

15. Install the oil pump driveshaft into the pump. Line up the cutout on the driveshaft with the inner rotor.

16. Place the two O-rings in position in the lower crankcase and replace the pump, drive gear, and gear cover.

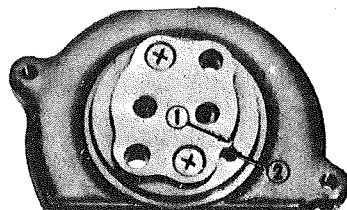

When fitting the cover, note that the lug of the cover should align with the notch of the pump body

XR75

		Standard mm (in.)	Serviceable Limit mm (in.)
TRANSMISSION			
Shift fork finger width		4.93-5.0 (0.1941-0.1969)	4.5 (0.1772)
Shift fork bore diameter		12.00-12.018 (0.4724-0.4731)	12.05 (0.4726)
Shift fork guide OD		11.976-11.994 (0.4715-0.4722)	11.9 (0.4685)
Shift fork guide pin-to-drum groove clearance		0.05-0.2 (0.0020-0.0079)	0.3 (0.0118)
Gear backlash	Low	0.085-0.169 (0.0033-0.0067)	—
	Second	0.089-0.179 (0.0035-0.0070)	0.2 (0.0079)
Gear backlash	Third and Fourth	0.084-0.170 (0.0033-0.0067)	—

65 cc Models

ENGINE			
Cylinder bore diameter (standard)		44.0 (1.734)	44.1 (1.738)
Piston OD (standard)		43.5 (1.714)	42.5 (1.708)
Piston-cylinder clearance		0.025-0.050 (0.001-0.002)	0.1 (0.004)
Piston ring side clearance	Compression	0.015-0.045 (0.0006-0.0018)	0.12 (0.005)
	Oil	0.010-0.045 (0.0004-0.0018)	0.12 (0.005)
Piston ring end-gap	Compression	0.15-0.35 (0.006-0.014)	0.5 (0.020)
	Oil	0.1-0.35 (0.004-0.014)	0.5 (0.020)
Valve guide ID		5.5 (0.217)	5.53 (0.218)
Valve seat		5.5 (0.217)	5.44 (0.214)
Valve stem diameter	In	1.0-1.3 (0.040-0.051)	2.0 (0.080)
	Ex	5.5 (0.217)	5.44 (0.214)
Valve stem-guide clearance	In	0.010-0.030 (0.0004-0.0012)	0.06 (0.0023)
	Ex	0.030-0.050 (0.0012-0.0020)	0.08 (0.0032)
Valve spring free-length	Outer	27.4 (1.080)	26.2 (1.030)
	Inner	25.1 (0.990)	23.9 (0.940)
Connecting rod big end radial clearance		0-0.012 (0-0.0005)	0.05 (0.002)
Connecting rod big end axial clearance		0.10-0.35 (0.004-0.014)	0.6 (0.024)
Crankshaft run-out		0.015 (0.0006)	0.05 (0.002)
TRANSMISSION			
Friction disc thickness		3.5 (0.138)	3.1 (0.122)
Plate warpage		—	0.15 (0.006)
Clutch spring free-length		19.2 (0.756)	18.2 (0.717)

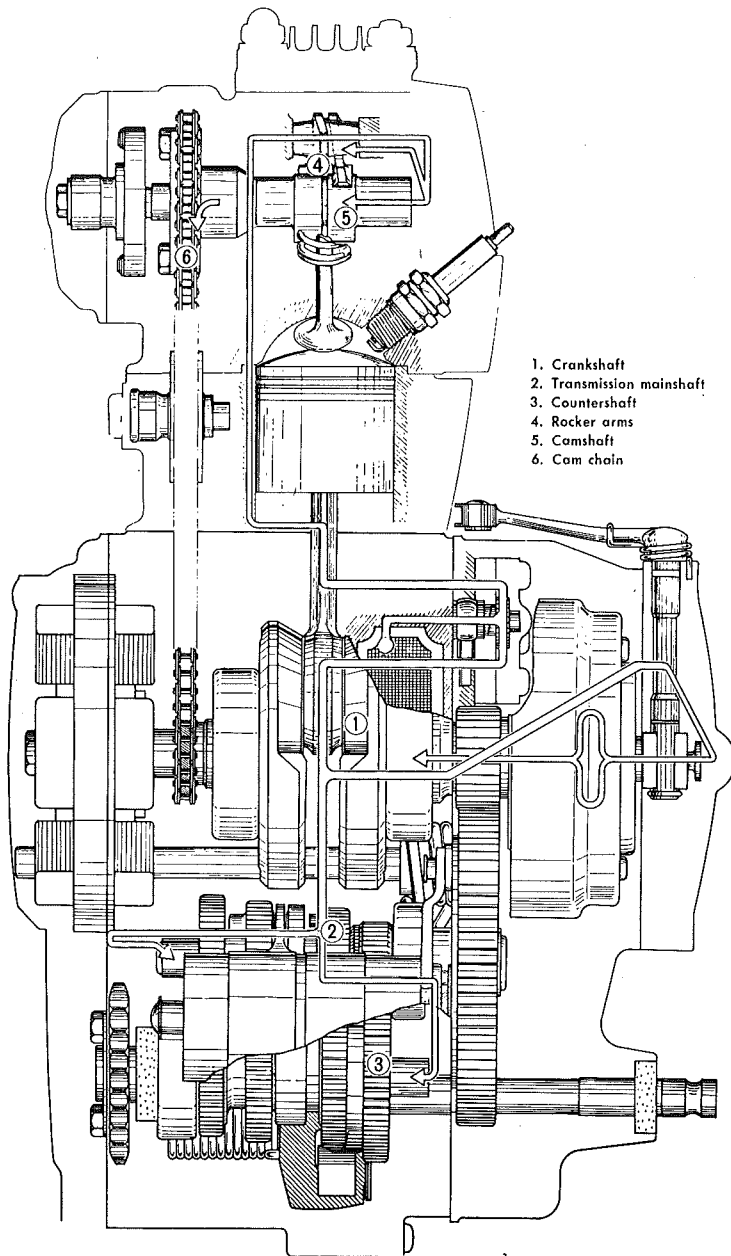

1. Crankshaft
2. Transmission mainshaft
3. Countershaft
4. Rocker arms
5. Camshaft
6. Cam chain

Oil circulation (90 cc)

Oil Pump Specifications

Model	Standard	Serviceable Limit
<i>50-90 cc</i>		
Rotor-pump body clearance (mm/in.)	0.10-0.15/0.004-0.006	0.20/0.0079
Rotor-top of body clearance (mm/in.)	0.02-0.07/0.008-0.027	0.12/0.0047
Rotor-rotor clearance (mm/in.)	0.02-0.07/0.008-0.027	0.12/0.0047
<i>XR75</i>		
Rotor-pump body clearance (mm/in.)	0.15/0.0059	0.20/0.0079

Model	Standard	Serviceable Limit
Rotor-rotor clearance (mm/in.)	0.15/0.0059	0.20/0.0079
<i>100-125 cc</i>		
Rotor-pump body clearance (mm/in.)	0.15-0.20/0.006-0.008	0.25/0.01
Rotor-rotor clearance (mm/in.)	0.15/0.006	0.20/0.0079

Honda 4-Stroke Singles

50 cc Models

		Standard mm (in.)	Serviceable Limit mm (in.)
ENGINE			
Cylinder bore diameter (standard)		39.0 (1.54)	39.1 (1.55)
Piston diameter (standard)		39.98-39.00 (1.534-1.535)	38.88 (1.530)
Piston-cylinder clearance		0.025-0.050 (0.001-0.002)	0.1 (0.004)
Piston ring side clearance	Compression	0.015-0.045 (0.0006-0.0018)	0.12 (0.005)
	Oil	0.010-0.045 (0.0004-0.0018)	0.12 (0.005)
Piston ring end-gap	Compression	0.15-0.35 (0.006-0.014)	0.5 (0.020)
	Oil	0.1-0.35 (0.004-0.014)	0.5 (0.020)
Valve guide ID		5.5 (0.217)	5.53 (0.218)
Valve seat		1.0-1.3 (0.040-0.051)	2.0 (0.080)
Valve stem diameter	In	5.5 (0.217)	5.44 (0.214)
	Ex	5.5 (0.217)	5.44 (0.214)
Valve stem-guide clearance	In	0.010-0.030 (0.0004-0.0012)	0.06 (0.0023)
	Ex	0.030-0.050 (0.0012-0.0020)	0.08 (0.0032)
Valve spring free-length	Outer	28.1 (1.106)	26.9 (1.060)
	Inner	25.1 (0.990)	23.9 (0.940)
Connecting rod big end radial clearance		0-0.012 (0-0.0005)	0.05 (0.002)
Connecting rod big end axial clearance		0.10-0.35 (0.004-0.014)	0.6 (0.024)
Crankshaft run-out		0.015 (0.0006)	0.05 (0.002)
TRANSMISSION			
Friction disc thickness		3.5 (0.138)	3.1 (0.122)
Plate warpage		—	0.15 (0.006)
Clutch spring free-length		19.6 (0.772)	18.2 (0.717)

NA Not available

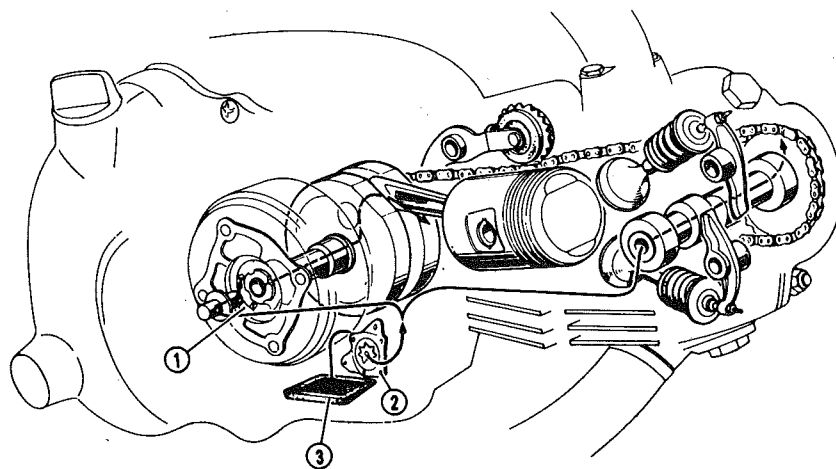

50-70 cc lubricating system: (1), centrifugal oil filter; (2), oil pump; (3), filter screen

FUEL SYSTEM

CARBURETOR

The following section deals with the removal and installation, and disassembly and assembly of the carburetor. Inspection and service is outlined under "Carburetor" in "General Information."

Removal and Installation

Procedures will vary depending on model.

1. Unscrew the carburetor cap and pull the throttle slide assembly out of the carburetor. If the slide assembly is to be disassembled, see the procedure below. If not, place a small plastic bag around the assembly to keep out dirt, and place it out of the way. Note that mishandling the assembly may necessitate replacement of the slide or needle.

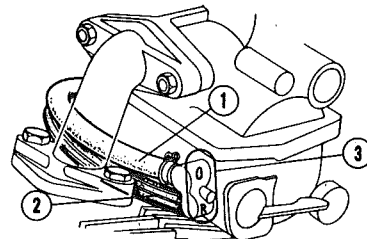

The main (1) and reserve (2) fuel lines must be correctly connected

2. On models which have the fuel petcock located on the carburetor float bowl (CT and ST models for example), pinch off the fuel main and reserve lines with a small C-clamp or the like; move the fuel line clips back up the line and disconnect the main and reserve lines from the carburetor. Be sure to note where each line is connected before disconnecting them.

Alternately, loosen the carburetor drain knob, turn the petcock to "reserve" and allow the contents of the tank to drain into a container by way of the drain line.

3. On other models, check that the fuel is shut off, and disconnect the fuel line from the carburetor.

4. Remove the float bowl drain plug (if fitted) and drain off any gas in the float bowl. Disconnect any overflow or breather tubes.

5. Loosen the carburetor or manifold mounting nuts a bit at a time until loose, then remove them.

6. Loosen the air cleaner hose clamp or band. Remove the carburetor.

7. Installation is the reverse of the above, but the following points should be noted:

a. Be sure that the carburetor mounting flange O-ring is installed in its groove before fitting the carburetor;

b. When tightening the carburetor or manifold flange nuts, do so evenly to prevent warpage;

c. On models with a carburetor mounted petcock, note that the petcock

Honda 4-Stroke Singles

pipes are marked. Be sure to connect the correct line to the pipes;

d. Lubricate the throttle slide if desired with a molybdenum or graphite lubricant. Insert it into the carburetor with the slide cutaway facing away from the engine. Be sure that the slot in the slide is engaged with the tab in the carburetor body;

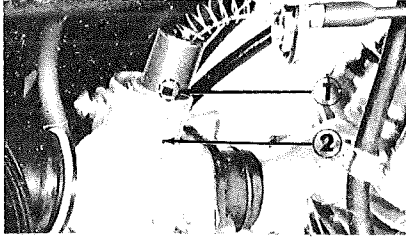

When fitting the slide, note that the slot in the slide (1) is engaged with the tab in the carb body

e. Be sure that the slide goes in easily, and especially that the needle enters the needle jet. Do not push or force the slide into place. If resistance is noted, it is probable that the needle is cocked to one side and is not entering the jet;

f. Tighten the carburetor cap and check throttle operation. The slide must move freely up and down.

Disassembly

1. If disassembly of the throttle slide components is desired, compress the return spring against the carburetor cap, disengage the cable from the slide, take out the spring clip, needle, and clip.

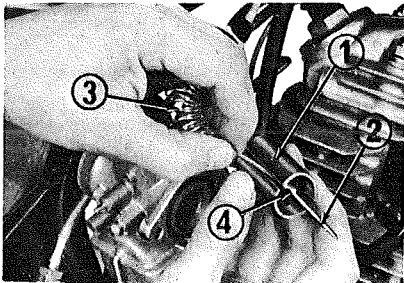

To disassemble the throttle slide, compress the return spring (3) and slip the cable end (4) out of the slide

2. Remove the float bowl petcock filter (if so equipped) by removing the filter plate, O-ring, and filter screen.

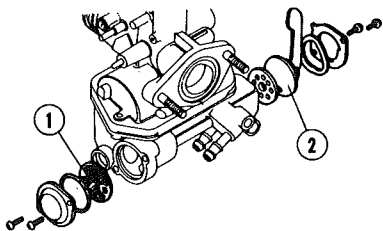

Carburetor-mounted petcock components: (1), filter screen; (2), lever

3. Remove the float bowl screws or flip up the retainer and separate the float bowl from the carburetor body. Do so carefully, to avoid damage to the floats.

Remove and discard the float bowl gasket.

NOTE: If the bowl is stuck, tap carefully with a plastic mallet to break the seal.

4. Push out the float pivot pin with a small dowel, and take out the floats. Remove the float needle from its seat. Unscrew the seat itself.

5. Unscrew the main jet.

6. Several types of needle jet (located directly above the main jet) are fitted. Some models have only the jet itself, while others have a jet holder or nozzle with the needle jet located above it. Unscrew the needle jet or jet holder if a means is provided (such as a hex head), or simply push the jet holder and/or jet out of the carburetor body with a wooden dowel.

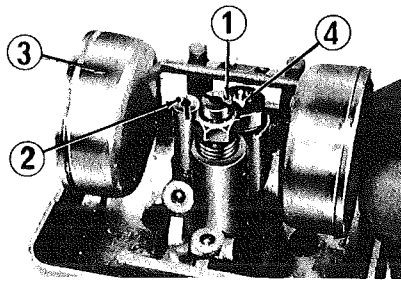

Main jet (1), pilot jet (2), floats (3), float needle (4)

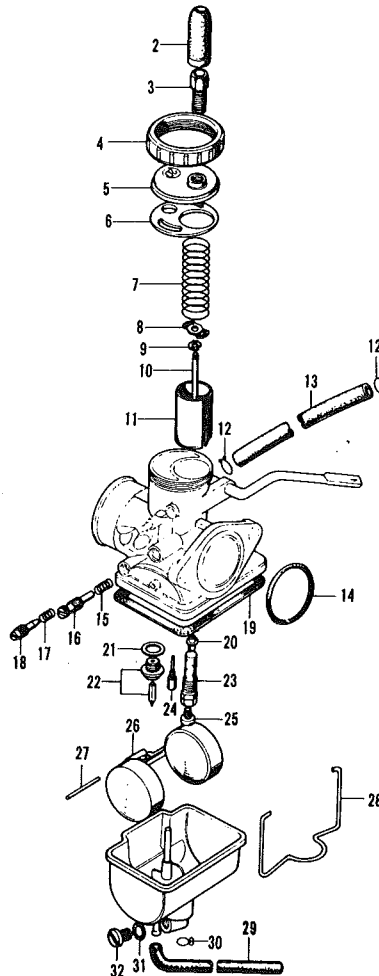

Carburetor assembly (100-125 cc)

7. Unscrew and remove the pilot jet.
8. Remove the pilot air and throttle stop screws and springs, and the drain knob (if fitted).

Assembly

Assembly is basically the reverse of the above, but note the following points:

1. Float bowl gaskets and manifold and needle jet O-rings (where fitted) should always be replaced with new ones. Other O-rings or fiber gaskets should be carefully inspected and replaced if less than perfect in condition. Check O-rings for tears or cracks, fiber gaskets for crushed condition.

2. Exercise care when installing jets. Install the needle jet, holder if fitted, main jet, pilot jet, and float needle seat.

Some models have an O-ring on the needle jet which must be in place.

CAUTION: Do not overtighten the jets as they are made of soft brass which is easily damaged.

3. Install the float needle into its seat. Hold the floats in place and install the pivot pin.

4. Assemble the throttle slide.

5. Install the pilot air screw, turning it in until lightly seated, then backing it out the proper number of turns as listed in the chart at the end of this chapter.

6. After completing assembly, install the carburetor on its manifold. If the carburetor bolts to the manifold, make sure that the bolts or nuts are tightened evenly, but not overtightened.

7. Check for fuel or air leaks; make final adjustments to the throttle stop and pilot air screws.

Atomizer Plate

An atomizer plate has been fitted to the intake manifold on some 1976 models. The plate needs no service or maintenance, but if removed, it must be installed in the correct way. Refer to the illustration of the unit.

1. Carburetor assembly
2. Cable boot
3. Cable adjuster
4. Cap ring
5. Cap
6. Cap plate
7. Throttle slide return spring
8. Clip plate
9. Needle clip
10. Needle
11. Throttle slide
12. Circlip
13. Feed line
14. Manifold O-ring
15. Holder spring
16. Throttle stop screw
17. Holder spring
18. Pilot air screw
19. Float bowl gasket
20. Needle jet
21. Float needle seat gasket
22. Float needle and seat
23. Main nozzle, needle jet holder
24. Pilot jet
25. Main jet
26. Float assembly
27. Pivot pin
28. Float bowl retainer
29. Overflow line
30. Circlip
31. Gasket
32. Drain plug

Honda 4-Stroke Singles

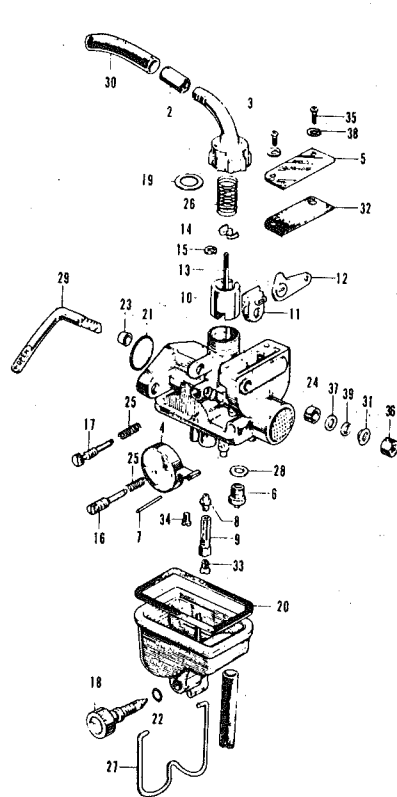

Z50 carburetor (early)

- | | |
|-----------------------------------|----------------------------|
| 1. Carburetor assembly | 20. Float bowl gasket |
| 2. Cable adjuster | 21. Manifold O-ring |
| 3. Cap | 22. Drain knob O-ring |
| 4. Float | 23. Seal |
| 5. Choke cover | 24. Seal seat |
| 6. Float needle seat | 25. Holder spring |
| 7. Pivot pin | 26. Throttle return spring |
| 8. Needle jet | 27. Float bowl retainer |
| 9. Main nozzle, needle jet holder | 28. Needle seat gasket |
| 10. Throttle slide | 29. Choke lever |
| 11. Choke valve | 30. Cable boot |
| 12. Choke arm | 31. Washer |
| 13. Needle | 32. Choke cover gasket |
| 14. Needle clip plate | 33. Main jet |
| 15. Clip | 34. Pilot jet |
| 16. Pilot air screw | 35. Screw |
| 17. Throttle stop screw | 36. Mounting nut |
| 18. Drain knob | 37. Washer |
| 19. Washer | 38. Lockwasher |
| | 39. Lockwasher |

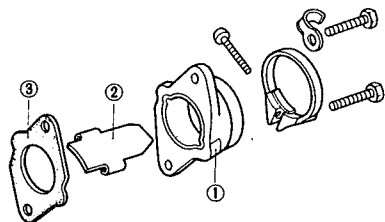

Manifold (1), atomizer plate (2), gasket (3). (1976 models)

FUEL PETCOCK AND LINES

Cleaning

1. On models with the petcock located

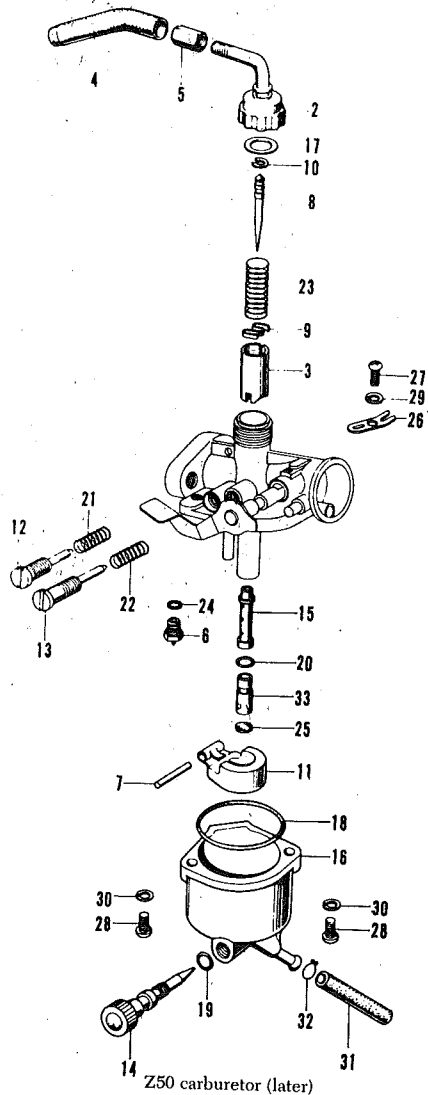

Z50 carburetor (later)

- | | |
|---------------------------------|--------------------------------|
| 1. Carburetor assembly | 17. Washer |
| 2. Carb cap | 18. Float bowl O-ring |
| 3. Throttle slide | 19. Drain knob O-ring |
| 4. Cable boot | 20. Main jet O-ring |
| 5. Cable adjuster | 21. Pilot air screw spring |
| 6. Float needle and needle seat | 22. Throttle stop screw spring |
| 7. Float pivot pin | 23. Throttle return spring |
| 8. Needle | 24. Needle seat O-ring |
| 9. Needle clip plate | 25. Gasket |
| 10. Needle clip | 26. Clip plate |
| 11. Float | 27. Screw |
| 12. Pilot air screw | 28. Float bowl screw |
| 13. Throttle stop screw | 29. Lockwasher |
| 14. Drain knob | 30. Lockwasher |
| 15. Needle jet | 31. Fuel line |
| 16. Float bowl | 32. Circlip |
| | 33. Main jet |

on the carburetor float bowl, turn the fuel off, remove the filter screen cover plate (two screws), then remove the O-ring and filter screen.

2. On models with the petcock on the gas tank, unscrew and remove the sediment bowl, and take out the O-ring and filter screen.

3. Some models are not equipped with a sediment bowl, and removal of the petcock is required to clean the filter. See below.

4. Clean the metal parts in solvent. Check that the filter screen is not punctured, and that the O-ring is not torn or otherwise damaged.

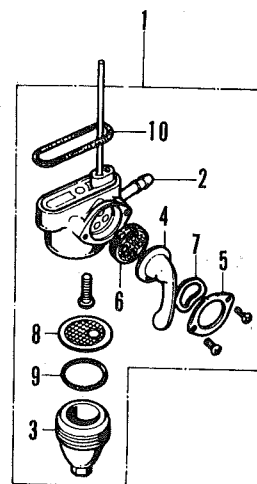

Petcock components

- | | |
|---------------------|-----------------------------|
| 1. Petcock assembly | 7. Spring |
| 2. Petcock body | 8. Filter |
| 3. Sediment bowl | 9. O-ring for sediment bowl |
| 4. Petcock lever | 10. O-ring for petcock body |
| 5. Lever plate | |
| 6. Gasket | |

5. Run a little gasoline through the petcock to flush out any dirt. Catch the gas in a suitable container. Turning the petcock to "Reserve" for a few seconds should remove the better part of any water or dirt in the bottom of the gas tank.

6. Check petcock operation in all operations. There must be no fuel flow when the petcock lever is turned to the "stop" position.

7. Replace the filter screen, O-ring, and sediment bowl or cover plate in that order. Check for leaks before operating the motorcycle.

Disassembly

At somewhat more extended intervals, the petcock should be removed from the gas tank or carburetor and cleaned.

1. Drain the gas tank completely. Disconnect the fuel line(s) from the petcock.

2. On petcocks which have sediment bowls, remove the bowl, O-ring and filter screen.

3. Remove the phillips screws beneath the filter screen and remove the petcock from the gas tank.

4. On tank-mounted petcocks without a sediment bowl, unscrew the nut which secures the petcock to the tank and remove the petcock. Remove the filter screen and rubber gasket.

5. Remove the two screws from the fuel lever setting plate, and remove the setting plate, lever spring, lever, and gasket.

Inspection

1. Clean all metal parts in solvent and blow dry. Clean the filter screens thoroughly, or replace if there is evidence of punctures or damage.

2. Inspect the O-rings for damage and replace if any is noted, or if leakage was evident in the petcock. Check any gaskets for crushed or cracked condition. Inspect the lever spring for cracks or fatigue.

3. Inspect the fuel lines for cracks or

abrasion damage. Replace if any sort of fault is noted.

Assembly

1. Install the fuel valve gasket, lever, spring, and setting plate. Secure with the two screws.

2. Be sure that the petcock O-ring (if fitted) is properly seated, or that the gasket is in place.

3. Install the petcock on the tank. Fit the sediment bowl filter, O-ring, and bowl if applicable. Check for leaks.

4. Be sure that all fuel lines are firmly secured at their connections and that the safety circlips are in place.

ELECTRICAL SYSTEMS

IGNITION CIRCUIT

Hard starting or misfiring are often caused by ignition system troubles, but since electrical malfunctions are often trickier to pin down than carburetor faults, it is wise to ensure that systems other than the ignition are in serviceable condition before beginning any work.

1. In the event of hard starting, misfiring, or cutting out, first check that all electrical connections are clean and tight. If the machine will not start at all, check the fuse (near the battery) first.

2. On battery ignition machines, check the charge of the battery and recharge or replace it as necessary. Be sure that the battery terminals are clean and the connections secured tightly.

3. Check the ignition and kill switches for continuity.

4. Check the ignition timing for accuracy.

5. Remove the spark plug, clean it thoroughly, or replace it with a new one; gap the plug to 0.6-0.7 mm (0.024-0.028 in.). Connect it to its cap, and ground it against the cylinder head. Kick the engine over briskly. The spark produced should be thick and blue.

6. If there is no spark, or if the spark is weak and yellow, repeat the test using a piece of metal, such as a nail, inserted into the spark plug cap and held about 1/8 in. away from the cylinder. If the spark is healthy, the problem was the spark plug; if not, check the condition of the points. Inspect, clean, and gap the points or replace them if they are badly pitted or worn. If excessive arcing or sparking at the points is noted while the machine is running, the problem may be the condenser. A defective condenser will also cause new points to wear out quickly.

7. If the problem is not in the points or the spark plug, the spark plug cap should be checked. Noise suppressor caps are fitted, which are designed to eliminate radio interference and provide a hotter spark by means of a resistor in the cap. Sometimes the resistor breaks down, and the cap then becomes an open circuit. Remove the cap from the spark

Carburetor Specifications

Model	Z50	065/M	S65	C70	CT0M
Main jet	50	72	85	75	75
Air jet	100	150	150	150	150
Air screw (turns out)	1 1/4	1 1/4	1 1/2	1 1/2	1 1/4
Throttle slide	2.0	2.0	1.5	2.5	2.5
Pilot jet	38	35	38	35	35
Float level (in./mm)	0.7/18①	0.69/17.5	0.8/19.5	0.6/15.5	0.6/15.5

① K3-on—0.65/16.5

Model	CL70	CT70/H	SL70	XR75	S90
Main jet	72	60	68	100	85
Air jet	90	150	90	NA	150
Air screw (turns out)	1 1/4	1 3/4	1 1/2	1 1/4	1 1/4
Throttle slide	2.5	2.5	NA	NA	2.5
Pilot jet	38	35	40	38	38
Float level (in./mm)	0.3/7.0	0.78/20.0	0.28/7.0	0.83/21.0	②

② Keihin—0.78/19.5
Mikumi—0.95/24.0

Model	CL90/L	CD90	C90	CT90	CT90 (from Frame No. 000001A)
Main jet	85	90	75	72	80
Air jet	150	150	120	120	120
Air screw (turns out)	1 1/2	1 1/4	1	1 1/2	1 1/4
Throttle slide	2.5	2.5	2.0	2.0	2.5
Pilot jet	35	40	40	40	38
Float level (in./mm)	0.78/19.5	0.83/21.0	0.83/21.0	0.83/21.0	③

③ CT90—0.85/21.5
K1—0.94/23.5

Model	CT90(K2-on)	100 (to 75)	100(76)	125(To 75)	125(76)	TL125(76)
Main jet	80	110	105	105	110	92
Air jet	120	100	100	100	100	100
Air screw (turns out)	1	1 1/2	1 1/2	1 1/2	1 1/2	1
Throttle slide	2.5	2.5	2.5	NA	NA	NA
Needle clip (groove from top)	NA	NA	2	NA	2	2
Pilot jet	38	38	38	38	45	35
Float level (in./mm)	0.78/20.0	0.95/24.0	0.95/24.0	0.95/24.0④	0.95/24.0	0.95/24.0

④ TL125:0.85/21.5

NA Not available

Honda 4-Stroke Singles

plug lead, and ground the end of the lead against the cylinder head. If a fat, blue spark is produced when the engine is kicked over, the problem was the cap. Replace it with a new one.

8. If the cap checks out okay, carefully inspect the cable itself. Check for dirt or grease, cuts or cracks in the insulation, moisture, etc. If the lead is damaged, it must be replaced. This also involves replacing the coil.

9. If the trouble has not been pinpointed, the ignition coil windings should be checked for continuity, using an ohmmeter.

a. On battery ignition machines, disconnect the two low-tension coil leads and check for continuity between them. This is a check of the primary winding. If there is no continuity, replace the coil;

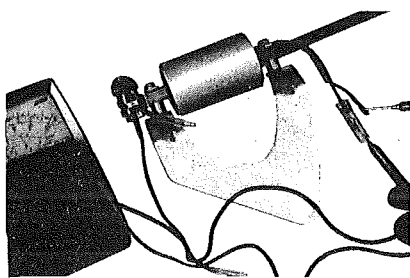

Checking ignition coil primary winding continuity (battery ignition)

b. On magneto ignition machines, check the primary winding by checking for continuity between the coil's low-tension wire (black or black/white) and the coil mounting plate. If continuity does not exist, replace the coil;

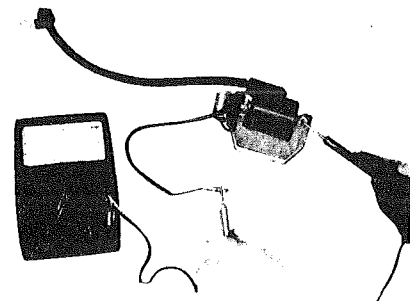

Checking primary winding continuity (magneto ignition)

c. On battery ignition machines, check for continuity across the coil's blue low-tension lead and the high-tension (spark plug) lead. Resistance may be very high (5-10,000 ohms), but continuity must exist. This checks the secondary winding;

d. On magneto ignition machines, check for continuity across the high-tension lead and the coil mounting bracket. If there is no continuity, replace the coil.

Even if continuity is present in the coil windings, it is possible that the coil is still defective. Replacing the coil temporarily with one which is known to be serviceable is recommended.

10. The condenser can be checked. If a capacitance tester is available,

Condensers should have a capacitance of approximately 0.25mf. Checking with a "megger" (high-voltage ohmmeter) should yield a resistance of 10M ohms at 1,000v.

On battery ignition machines, the checks above cover all ignition circuit components and the trouble should be evident. On magneto ignition bikes, the magneto itself must be checked if the cause of the problem has not yet been determined.

Assuming that all other ignition circuit components have been eliminated as the possible trouble spots, and the ignition and kill switches have been checked, proceed as follows:

1. Remove the left crankcase side-cover and the magneto rotor. A special puller must be used to remove the rotor.

2. Check the rotor for any score marks which would indicate that the rotor is contacting the core ends. If so, the condition must be remedied. If this has occurred, check for any play in the crankshaft which would indicate a bad crankshaft bearing. Other reasons may be improper mounting of the coil cores or rotor, worn crankshaft taper, or rotor taper surface. If the taper is damaged, the rotor should be replaced. Also inspect the rotor for any cracks or fractures. If present, replace.

3. Check for continuity between the black or black/white wire and ground. If continuity does not exist, the primary exciting coil is either broken internally, or is poorly grounded.

NOTE: If this test is made with the coils still on the engine, be sure that the points are open or held open with a bit of thick paper.

4. Check the resistance between the coil core and the mounting plate or crankcase cover. The coil core should be well grounded (no resistance).

CHARGING CIRCUIT

Battery Ignition Models

1. In the event that the battery overcharges, check the condition of the battery itself. A shorted or defective battery is the most likely cause.

2. If the battery discharges quickly, or fails to hold a charge, check the battery, rectifier, and alternator.

RECTIFIER

An ohmmeter or a continuity tester is used to check the rectifier. Do not use a megger.

1. Disconnect the rectifier leads at the plastic connector. There are four leads wired to the connector. This rectifier is the full-wave type, consisting of four diodes wired as shown in the illustration. To check the rectifier, you will be checking each diode in turn to ensure that current will flow through each in one direction only. Current flow in both directions, or no current flow in either direction through a diode indicates that it is defective.

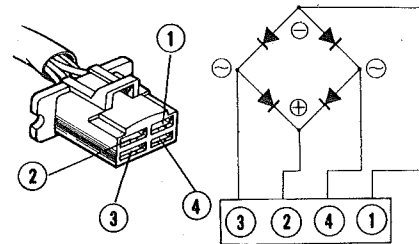

Full-wave rectifier leads

- 1. Green
- 2. Red/White
- 3. Yellow
- 4. Pink

2. Connect the negative lead of the tester to the green wire, and the positive lead to the yellow, red/white, and pink wires in turn.

In each case, note whether or not there is continuity.

NOTE: On an ohmmeter, "continuity" will be indicated by a resistance of 5-40 ohms. "No continuity" by a resistance of 100 or more ohms.

3. Now reverse the tester connections, connecting the positive tester lead to the green wire, and the negative to each of the others in turn.

In every case, the reaction of the tester must be the opposite of the first test; i.e., if the first test showed continuity between two leads, reversing the tester connections must show no continuity.

Continuity in both directions, or lack of continuity in both directions for any given pair of wires is indicative of a defective rectifier.

ALTERNATOR

1. A dynamic test may be carried out if a voltmeter and ammeter are available. The battery must be fully charged. Hook up the voltmeter across the battery terminals, and the ammeter to the positive terminal of the battery and to the red/white lead, as shown.

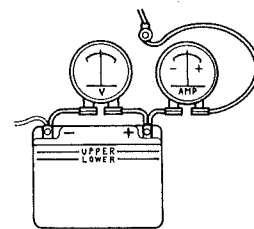

Voltmeter and ammeter connections to check alternator output

2. Start the engine and note the voltmeter and ammeter readings at the given rpm and compare them to those given in the "Alternator Output" chart for your machine. If the readings are not within the proper specifications, the stator coil should be removed from the machine and checked for continuity as outlined below.

3. Check for continuity between all three stator leads. Continuity must exist, or the stator assembly has a broken wire and it must be replaced.

4. Check for continuity between the yellow lead and the stator core. If continuity exists, there is a short, and the stator must be replaced.

Alternator Output

Lights	Beginning of Charging	5000 rpm
90 cc		
Off	6.8v, 1000 rpm	7.8v/1.3a
High beam	6.8v, 3500 rpm	7.2v/0.2a
Low beam	6.8v, 2200 rpm	7.8v/1.3a
100 cc		
Off	6.8v, 1000 rpm	7.8v/1.3a
High beam	6.8v, 3500 rpm	7.8v/1.3a
Low beam	6.8v, 2200 rpm	7.2v/1.3a
125 cc		
Off	6.8v, 1000 rpm	7.9v/1.7a
Low beam	6.8v, 2000 rpm	7.8v/1.3a

Magneto/Alternator Models

1. Rectifiers are fitted to models which have batteries. In the event that the battery overcharges, it is probable that the battery itself is faulty.

2. If the battery fails to hold a charge or discharges quickly, check the battery itself, then the rectifier and magneto lighting coil.

RECTIFIER

1. The rectifier is a simple half-wave unit which has two leads (red/white and green). To check the rectifier, disconnect these leads, and connect a test light or ohmmeter across the rectifier terminals. Note whether or not continuity exists. Now reverse the leads and note whether or not there is continuity.

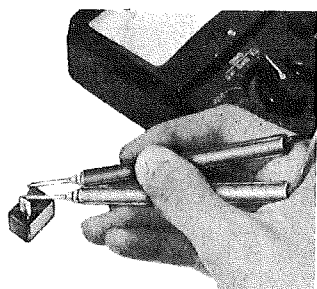

Checking the half-wave rectifier

2. There must be continuity in one direction only. If there is continuity in both directions or neither direction, the rectifier is defective. If an ohmmeter is used, resistance should be 5-40 ohms in the forward direction (continuity) and about 600 ohms for the reverse.

ALTERNATOR

1. To check the lighting coil, use an ohmmeter or continuity light.

2. Disconnect the alternator wiring at the plastic connector. Check for continuity between the green lead and ground on the engine case. Check for continuity between the yellow lead and ground. Check for continuity between the green and the yellow leads. Continuity must exist in all three cases or the lighting coil must be replaced.

3. If lights are dim on models which have no battery, suspect the magneto/alternator coil. Check for burned wiring, scored coil core ends, etc. Make continuity checks as in Step 2.

If the coil seems satisfactory, the rotor magnets may have become weakened. Replace the rotor if this has happened.

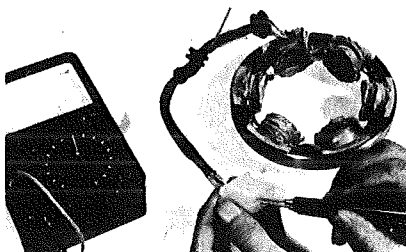

Checking for continuity between alternator leads

STARTING SYSTEM

The starting system consists of the starter motor and clutch, the solenoid, and the handlebar-mounted starter switch. When the button is pressed, the electrical circuit to the solenoid is closed and the solenoid is activated, sending the battery current directly to the starter motor. The starting system is quite reliable and it is unlikely that you will experience any major problems.

Testing

1. If the starter will not operate, switch on the headlight and observe its intensity. If it is dim when the starter is not being operated, check the battery connections and recharge the battery. If the headlight doesn't light, check the fuse, and the battery connections, and check the electrical continuity of the wire between the ignition switch and the battery.

2. If the headlight is bright, press the starter button momentarily and watch the light. If it remains bright, touch a screwdriver blade between the two starter solenoid terminals. If the starter operates, connect a test light between the small yellow/red wire on the solenoid and ground. If the test light comes on as the button is pushed, the solenoid is faulty. If it does not light, look for defective wiring between the starter button and the ignition switch, or simply a burned out starter button switch. If the starter does not operate and the headlight dims as the main solenoid terminals are bridged, the starter motor is faulty. If the headlight does not dim, look for a bad connection at the starter.

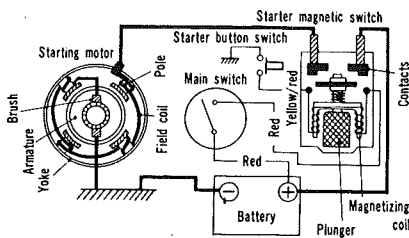

Electric starter wiring diagram

3. If the starter motor operates freely, but will not turn the engine over, the starter clutch is not operating (a rare occurrence). To remove the clutch it will be necessary to first take off the left-side crankcase cover and remove the alternator rotor. If the overrunning clutch is defective and the starter keeps spinning after the engine starts, it must be repaired immediately to prevent serious damage to the starter assembly.

Starter Motor Service

1. Check for electrical continuity between the commutator and armature core using a multimeter or test light and battery. If continuity exists, the armature coil is grounded and the armature or complete starter motor should be replaced.

2. Check continuity between the brush wired to the stator (field) coil and the starter motor cable terminal. Lack of continuity indicates that an open circuit exists in the stator coil and the starter motor unit should be replaced.

3. Examine the carbon brushes for damage to the contact surfaces and measure their length. Replace the brushes as a set if they are damaged in any way or if they measure less than 0.3 in. (7.5 mm).

4. Brush spring tension should be determined with a small spring scale. Replace the springs if they exert less than 0.8 lbs of tension.

5. Polish the commutator with fine emery cloth and blow it off thoroughly before installing it. Check the following components for excessive wear and damage: clutch spring and rollers; bearings; bushings; oil seal; reduction gears; and the sprockets. Replace all parts as necessary if worn or damaged. When reassembling the starter clutch, apply a thin coat of silicone grease to the rollers.

Starter Solenoid Service

The solenoid is an electromagnetic switch which closes and completes the circuit between the starter and the battery when activated by the starter button. The solenoid is a necessary addition to the starting circuit because the starter button switch is not capable of handling the amperage load required to operate the starter, and because mounting a heavy-duty switch on the handlebar, with the large cable needed to handle the load, is impractical.

If the solenoid does not work, check the continuity of the primary coil by connecting a multimeter or test light and battery to the two small solenoid leads. Lack of continuity indicates an open circuit and the solenoid must be replaced. If the primary coil winding is continuous, disassemble the solenoid and clean the contact points with emery paper or a small file. The points, after long use, have a tendency to become pitted or burned due to the large current passing across them. Be sure to disconnect the battery before disconnecting the cables from the solenoid when it is to be removed. Replace the solenoid if cleaning the points fails to repair it.

Honda 4-Stroke Singles

WIRING DIAGRAMS

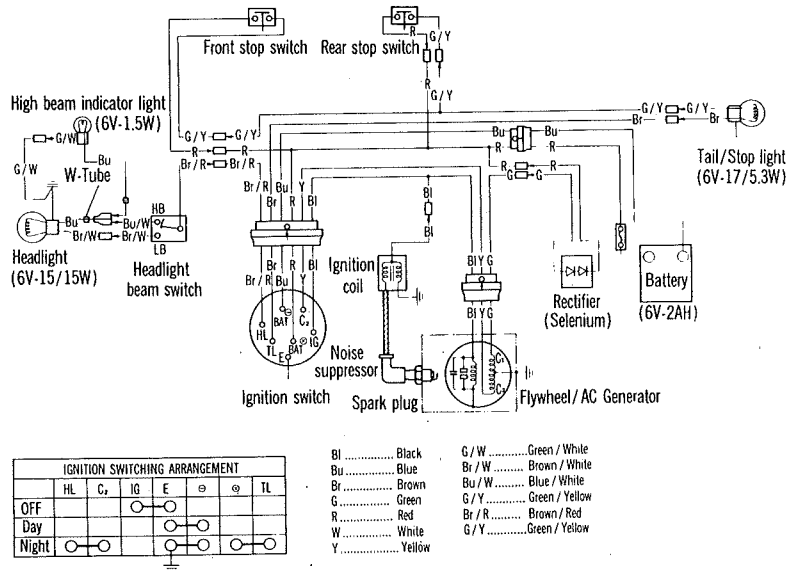

Z50 (from Frame No. 120001)

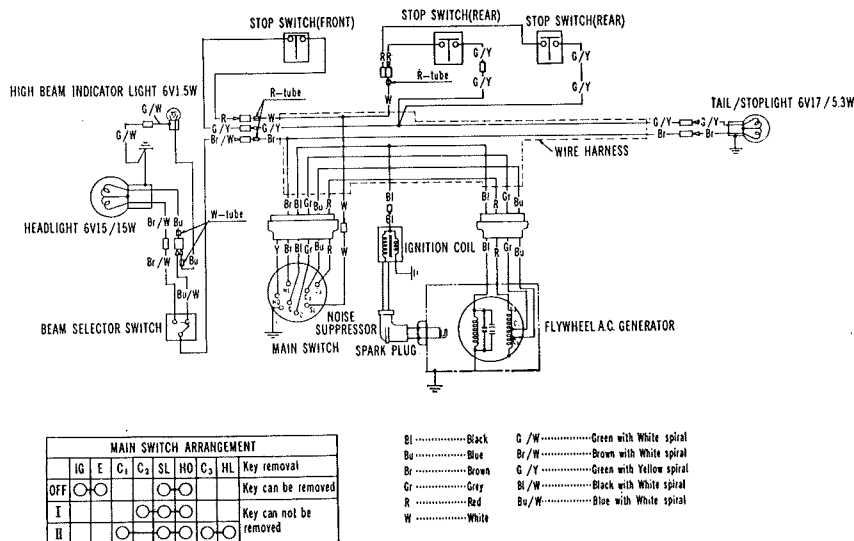

Z50 (from Frame No. 270236)

WIRING DIAGRAMS

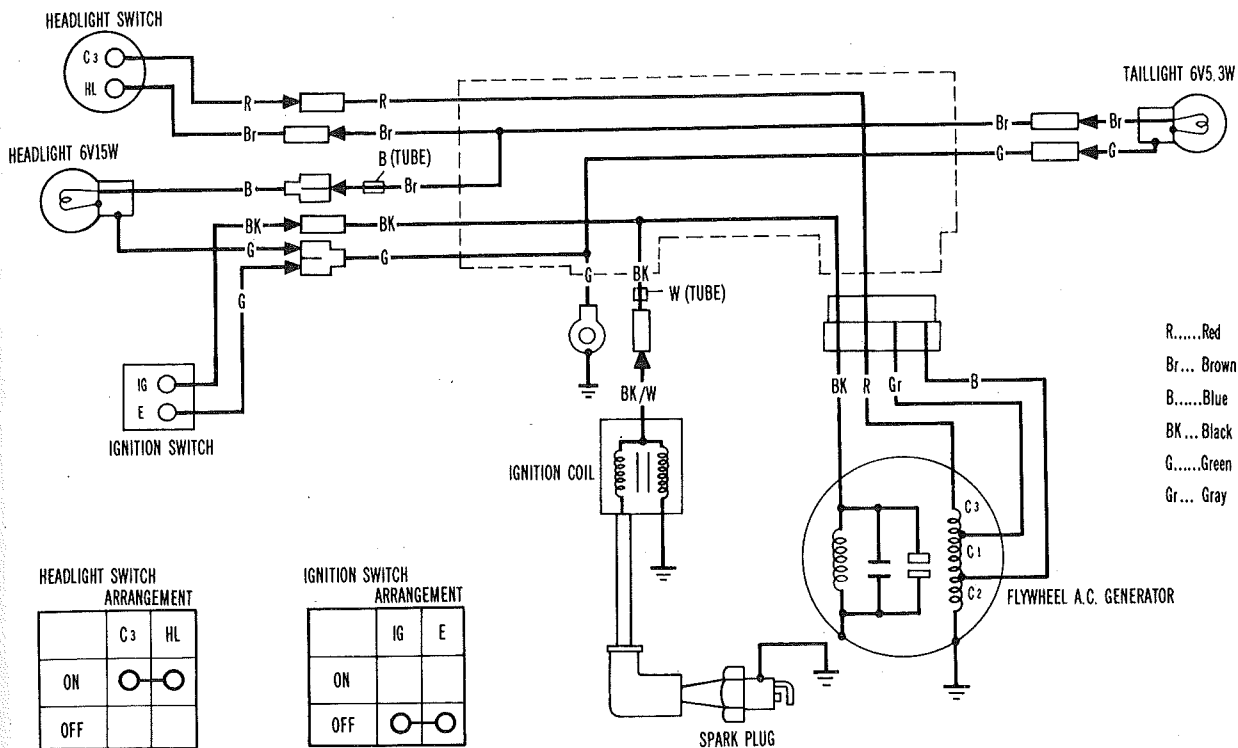

Z50 K4-on

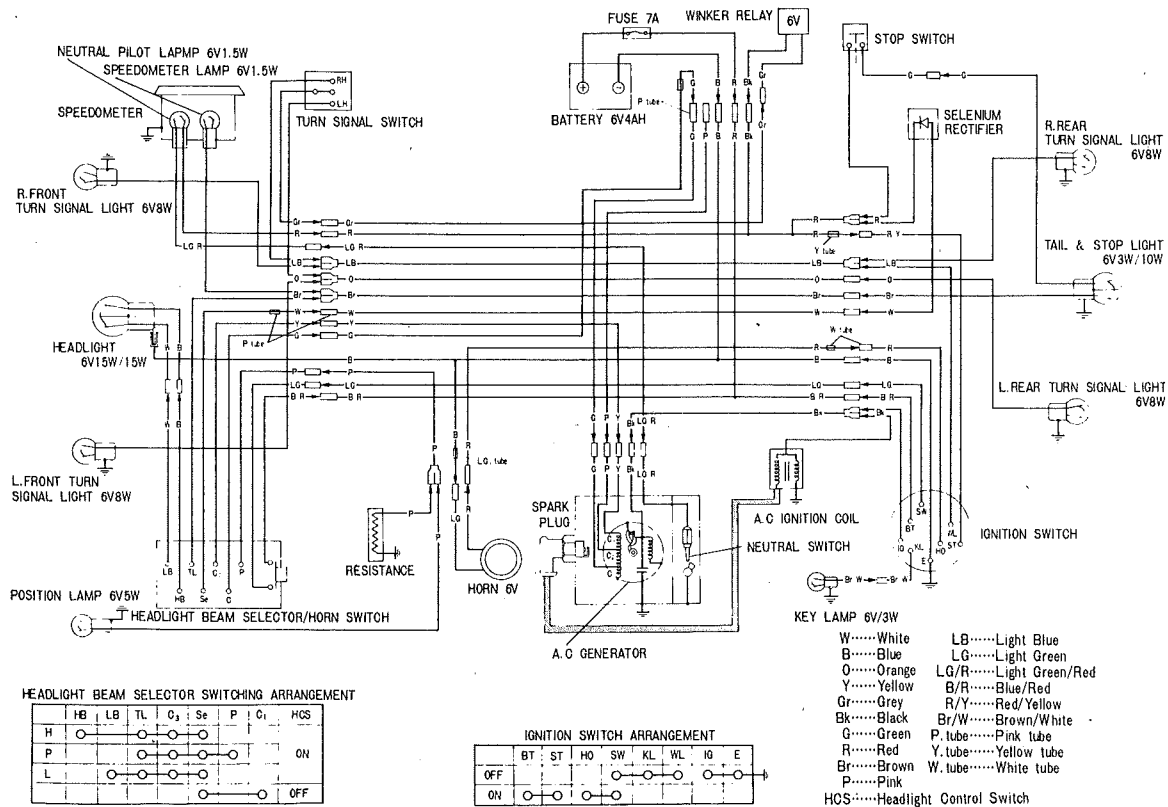

C65, C70

Honda 4-Stroke Singles

WIRING DIAGRAMS

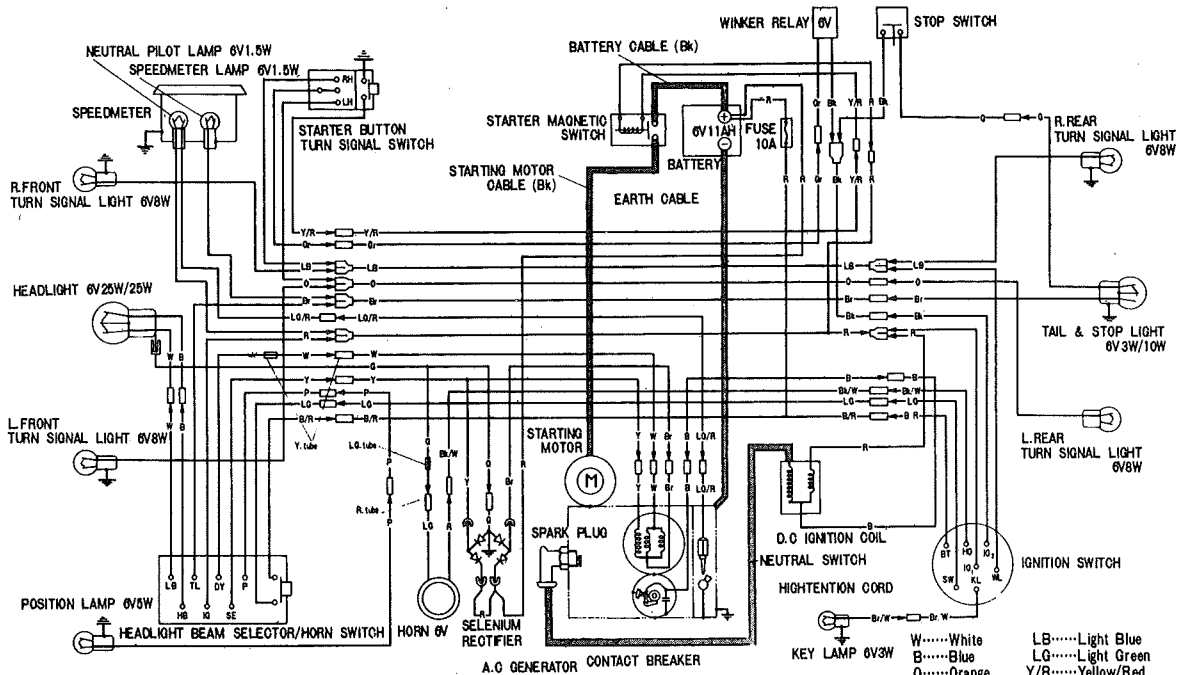

HEADLIGHT BEAM SELECTOR SWITCHING ARRANGEMENT

	P	HB	TL	LB	IO	DY	SE	HCS
L	○	○	○	○	○	○	○	ON
P	○	○	○	○	○	○	○	ON
H	○	○	○	○	○	○	○	OFF

IGNITION SWITCH ARRANGEMENT

	BT	IO ₁	IO ₂	HO	SW	KL	WL
OFF	○	○	○	○	○	○	○
ON	○	○	○	○	○	○	○

- W.....White
- B.....Blue
- O.....Orange
- Y.....Yellow
- Gr.....Gray
- Bk.....Black
- G.....Green
- R.....Red
- Br.....Brown
- P.....Pink
- HCS.....Headlight Control Switch
- LB.....Light Blue
- LG.....Light Green
- Y/R.....Yellow/Red
- LG/R.....Light Green/Red
- B/R.....Blue/Red
- Bk/W.....Black/White
- Br/W.....Brown/White
- Y. tube.....Yellow tube
- LG. tube.....Light Green tube
- R. tube.....Red tube

C65M, C70M

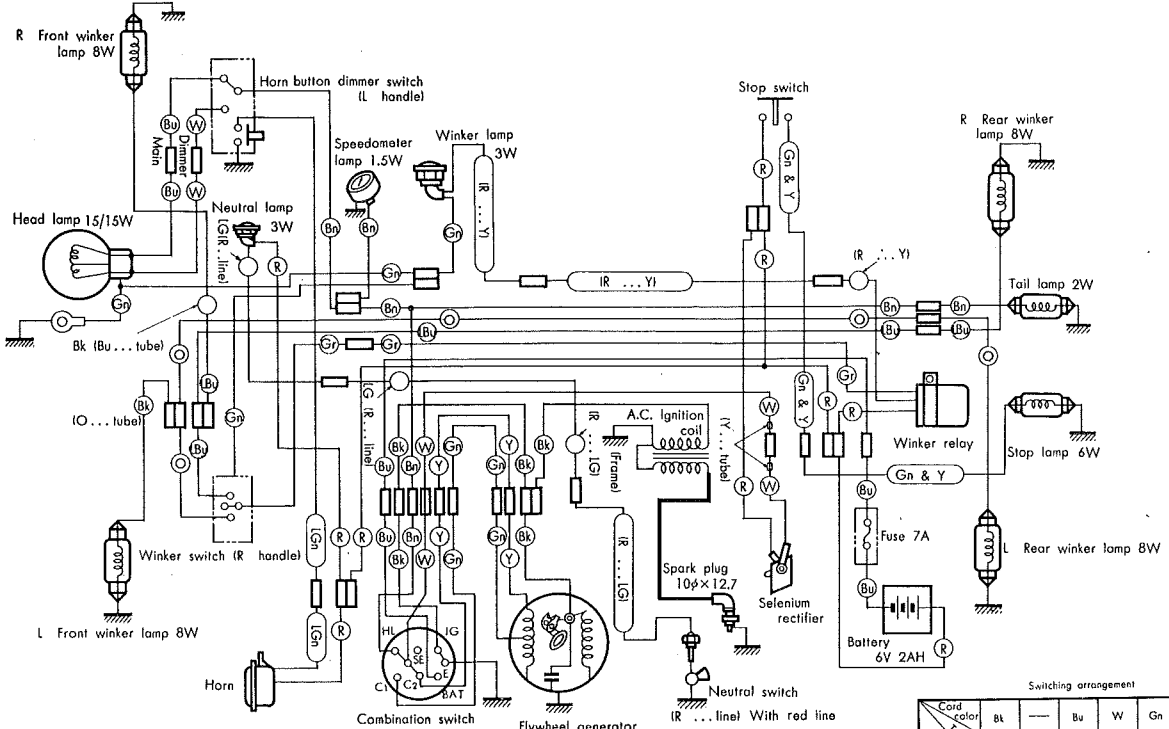

- Bk.... Black
- Bu.... Blue
- Bn.... Brown
- Gr.... Gray
- LGn.... Light green
- O.... Orange
- R.... Red
- W.... White
- Gn.... Green
- Y.... Yellow
- LBu.... Light blue
- D/Br.... Dark brown
- (Bu...tube) Covered with blue empire tube
- IO...tube) Covered with orange empire tube
- Y.... Yellow
- Y...tube) With varnish tube
- IR...Y) Red spiral on yellow
- IR...LG) Red spiral on light green

Switching arrangement

Position	Color	Bk	Bu	W	Gn	Y	Bn
OFF	IG	○	○	○	○	○	○
1	E	○	○	○	○	○	○
2	BAT	○	○	○	○	○	○

WIRING DIAGRAMS

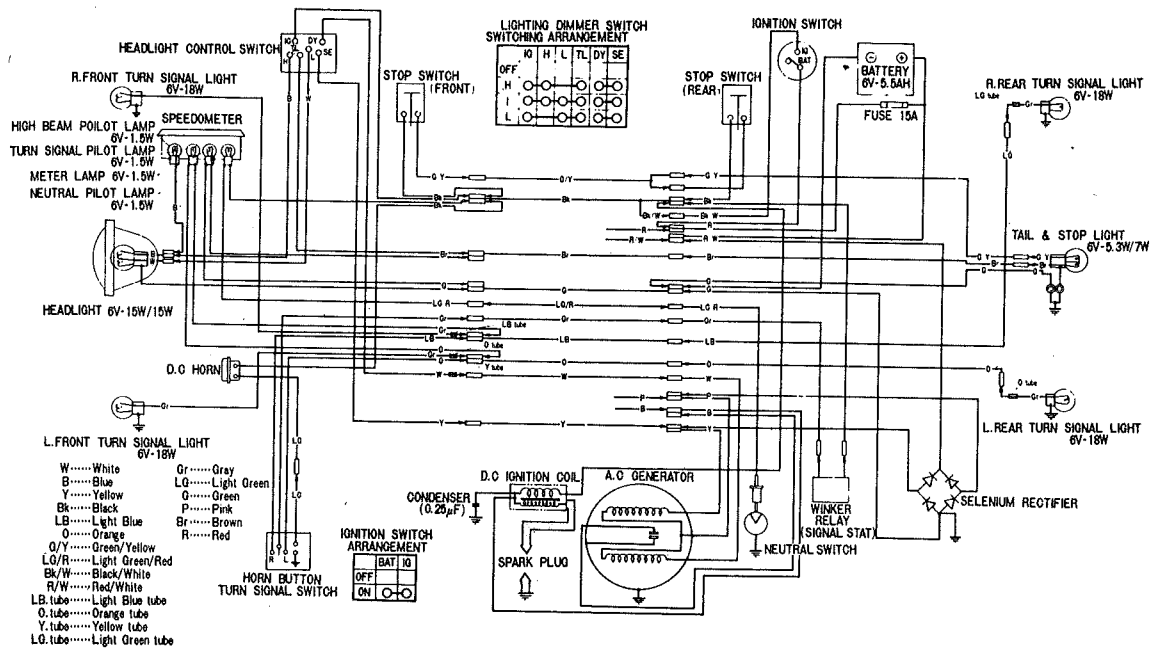

CL70

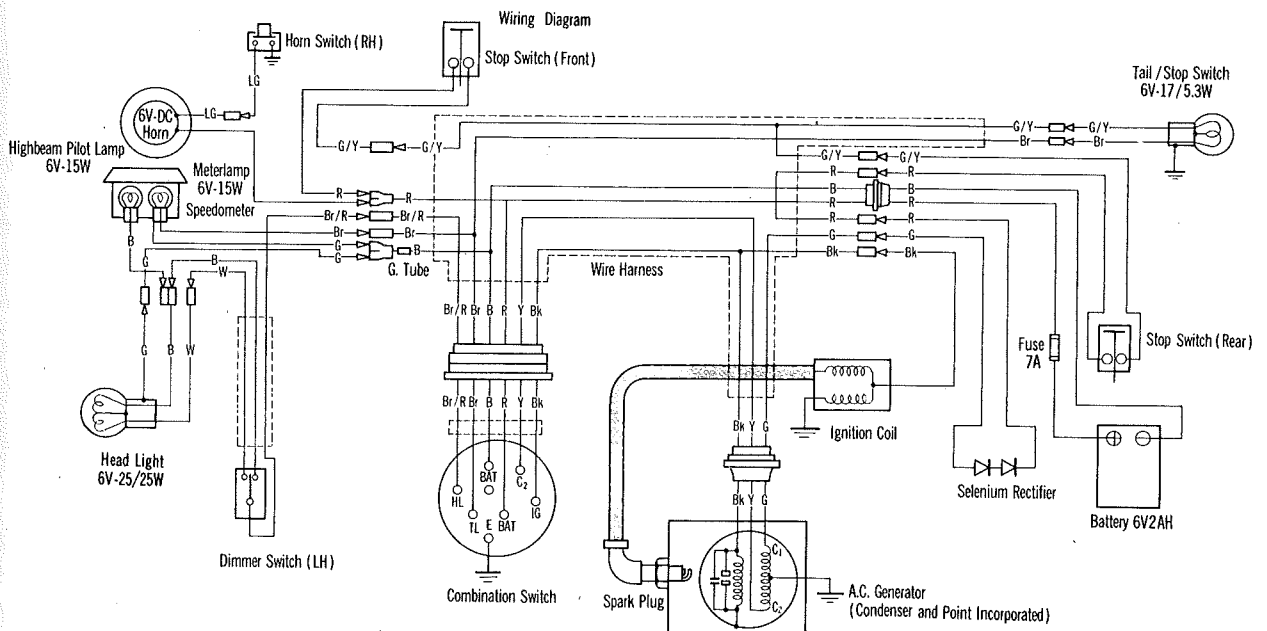

Combination Switching diagram		HL	C ₂	IG	E	BAT	BAT	TL
OFF				○		○	○	
I				○		○	○	
II		○	○			○	○	
Cord Color		BR/R	Y	BK		B	R	R

- W.....White
- B.....Blue
- O.....Orange
- Y.....Yellow
- Bk.....Black
- G.....Green
- R.....Red
- Br.....Brown
- P.....Pink
- HCS.....Headlight Control Switch
- LB.....Light Blue
- LG.....Light Green
- Y/R.....Yellow/Red
- LG/R.....Light Green/Red
- B/R.....Blue/Red
- Bk/W.....Black/White
- Br/W.....Brown/White
- Y tube.....Yellow tube
- LG tube.....Light Green tube
- R tube.....Red tube

CT70

Honda 4-Stroke Singles

WIRING DIAGRAMS

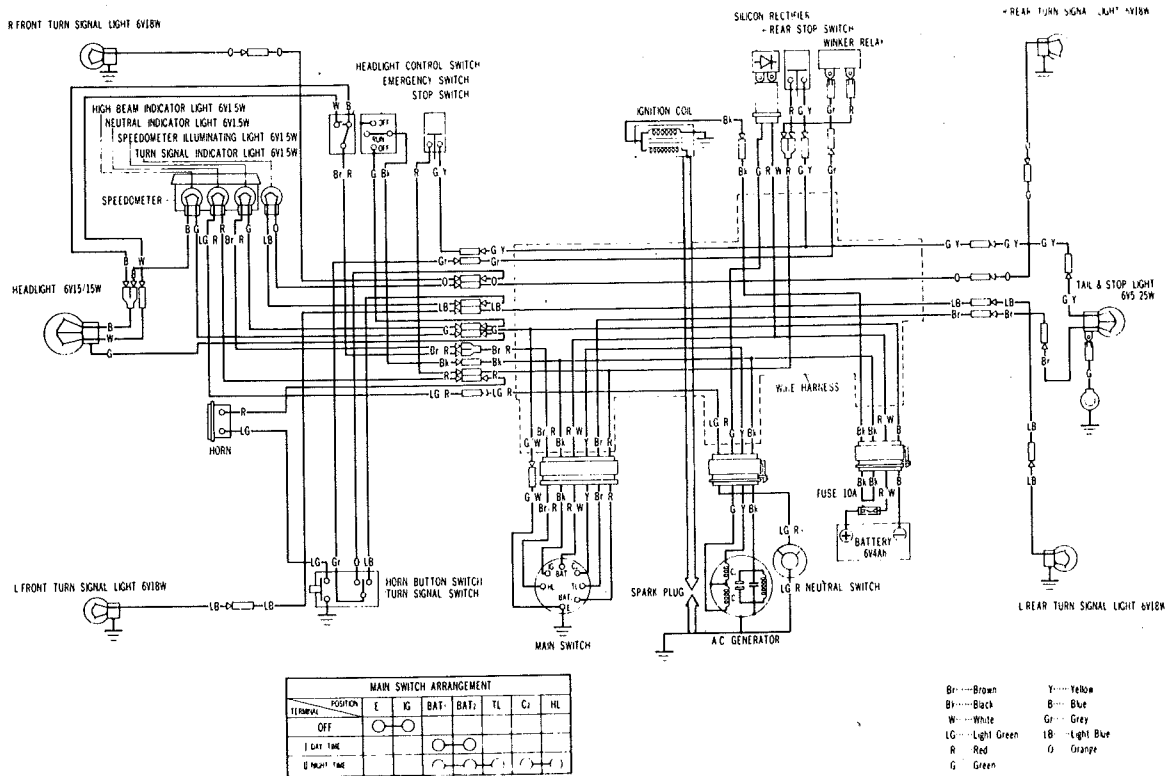

CT70K3

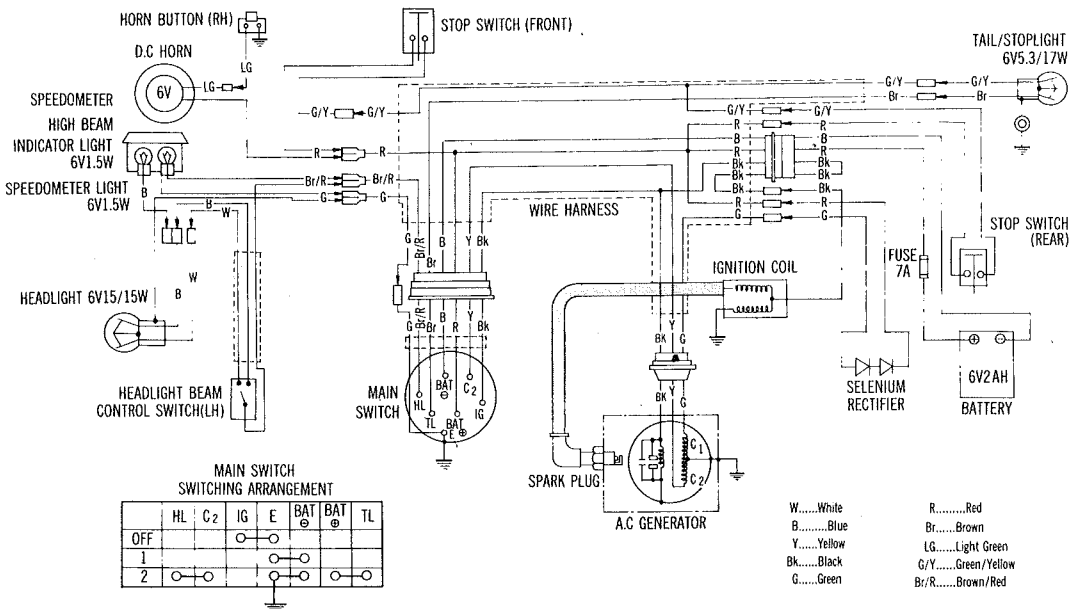

CT70H

WIRING DIAGRAMS

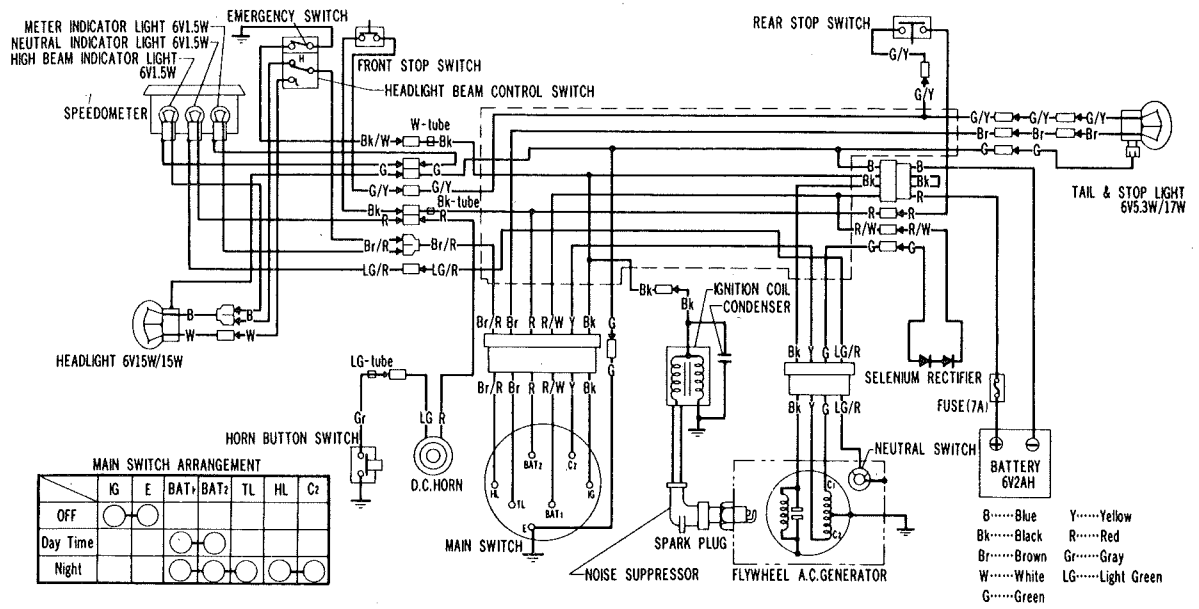

SL70

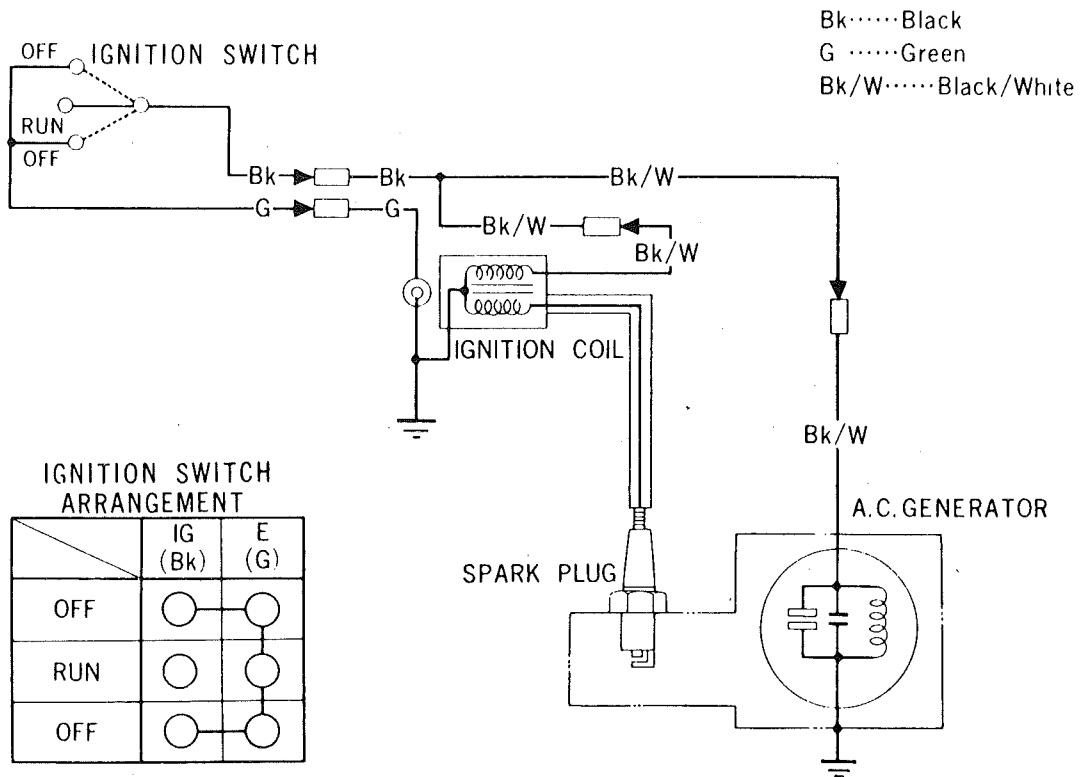

XR75

Honda 4-Stroke Singles

WIRING DIAGRAMS

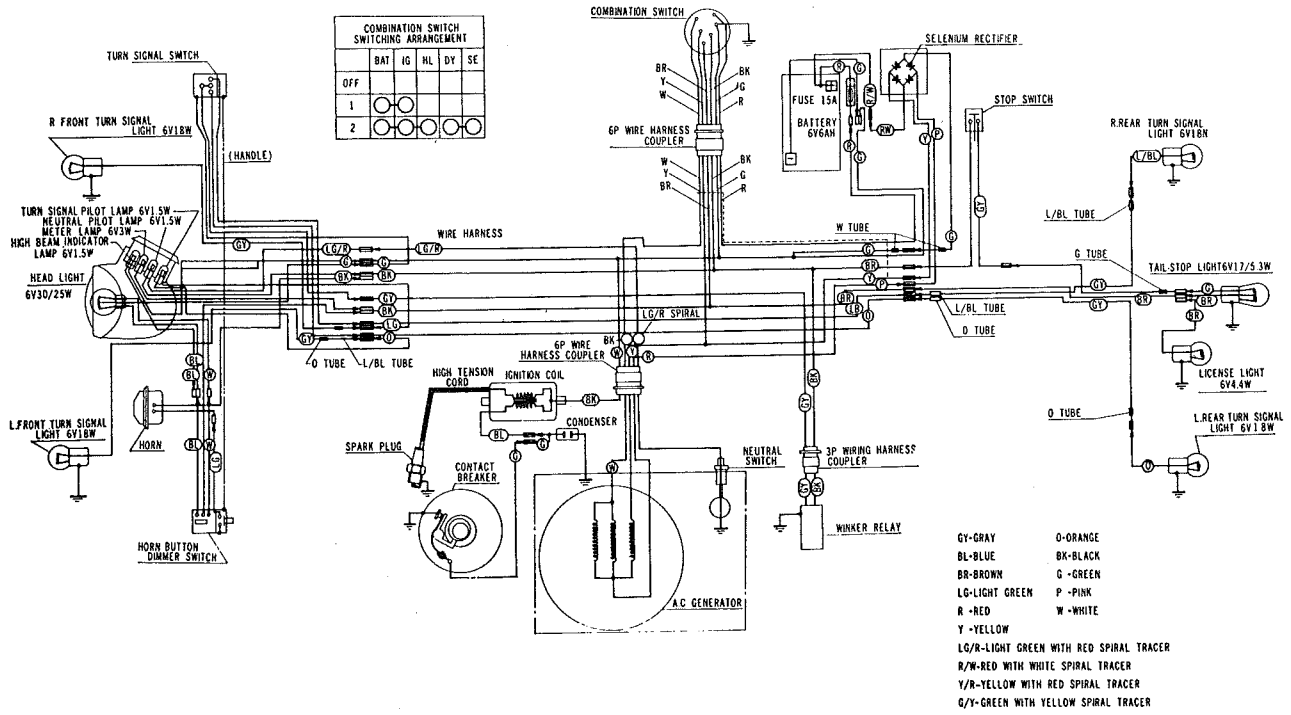

S90

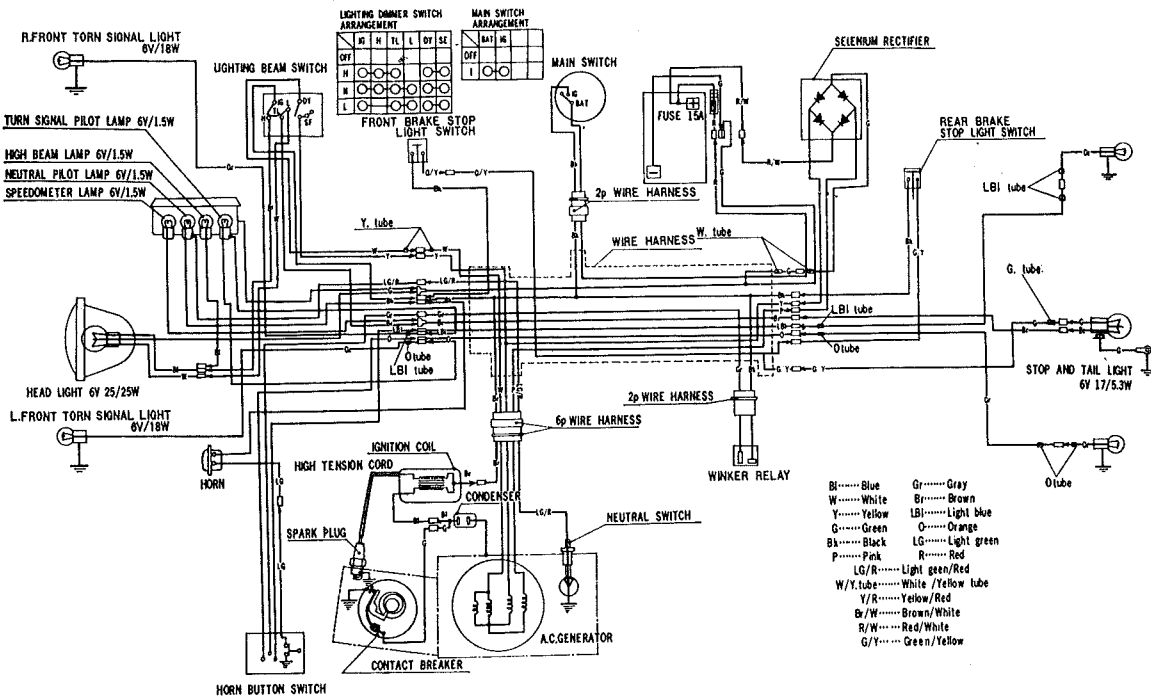

CL90/L

WIRING DIAGRAMS

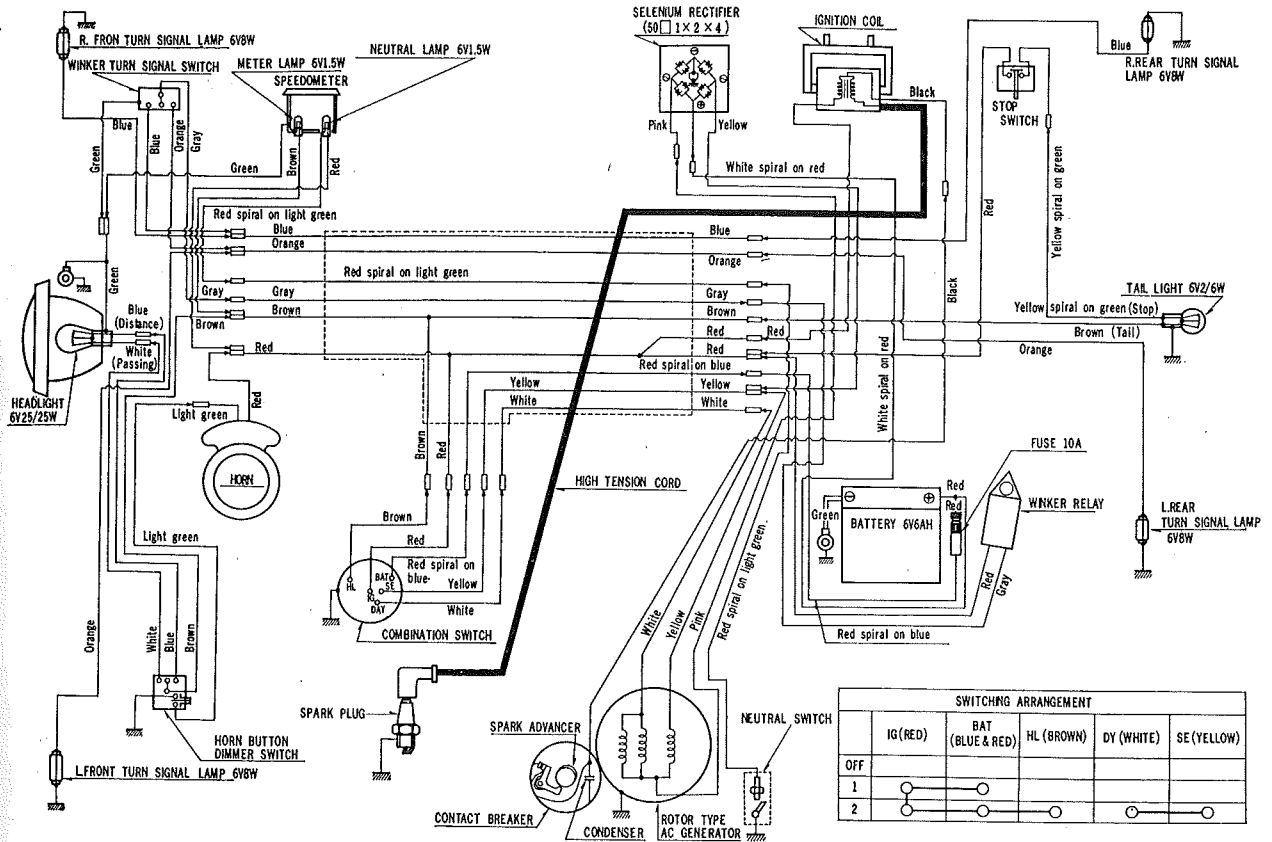

CD90

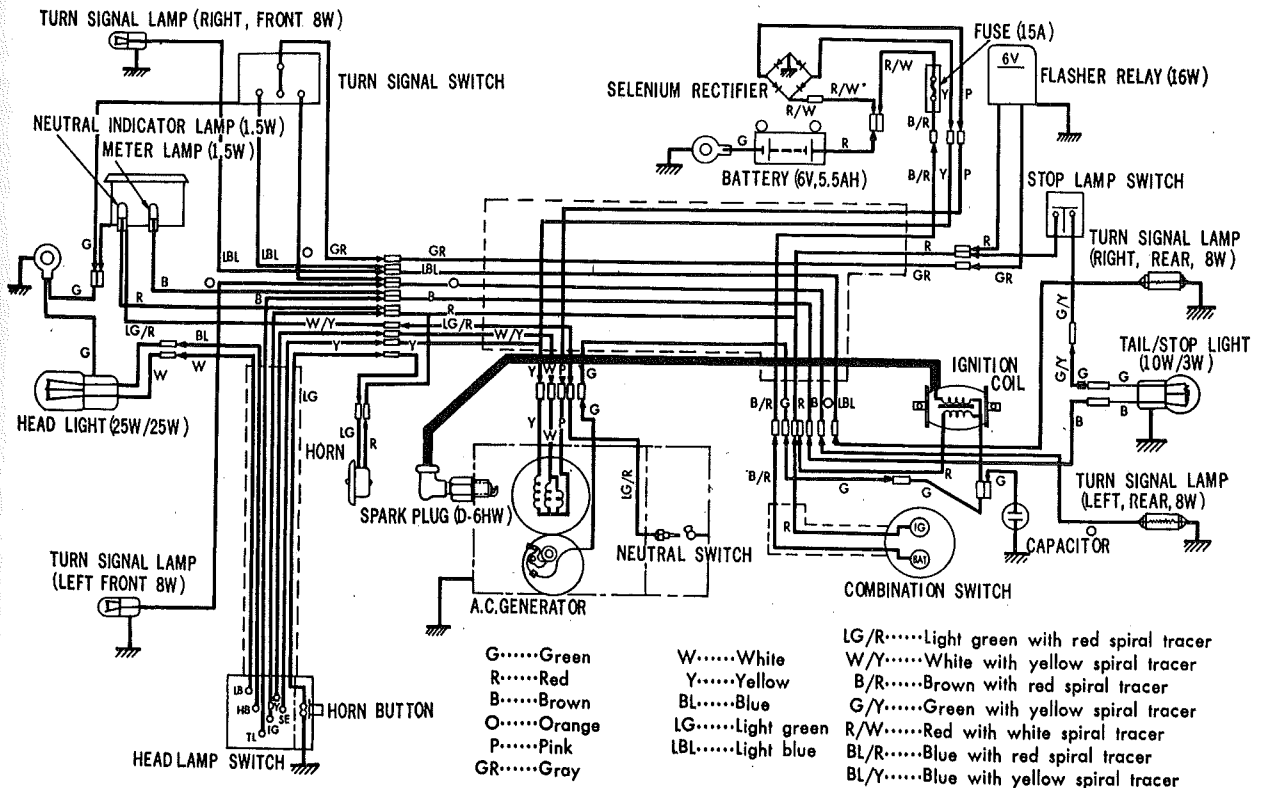

C90

WIRING DIAGRAMS

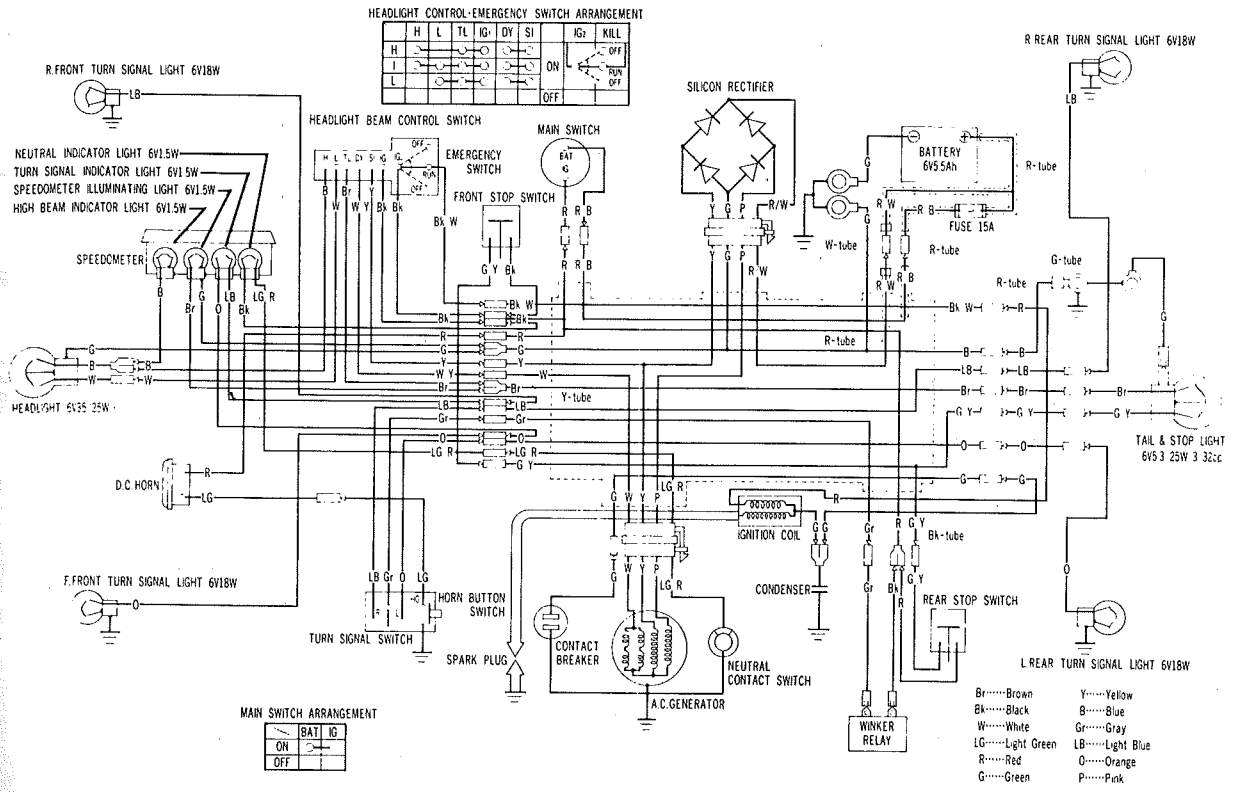

CT90K5

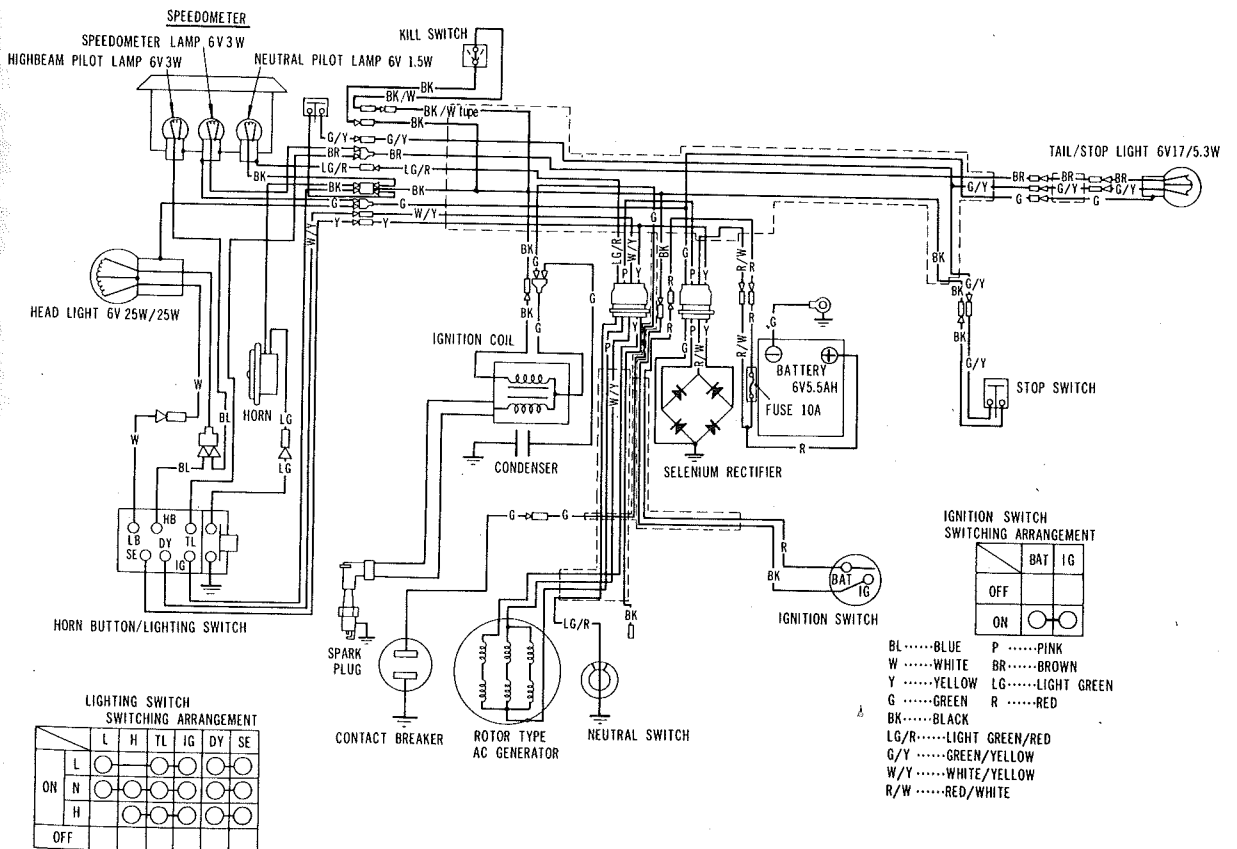

SL90

Honda 4-Stroke Singles

WIRING DIAGRAMS

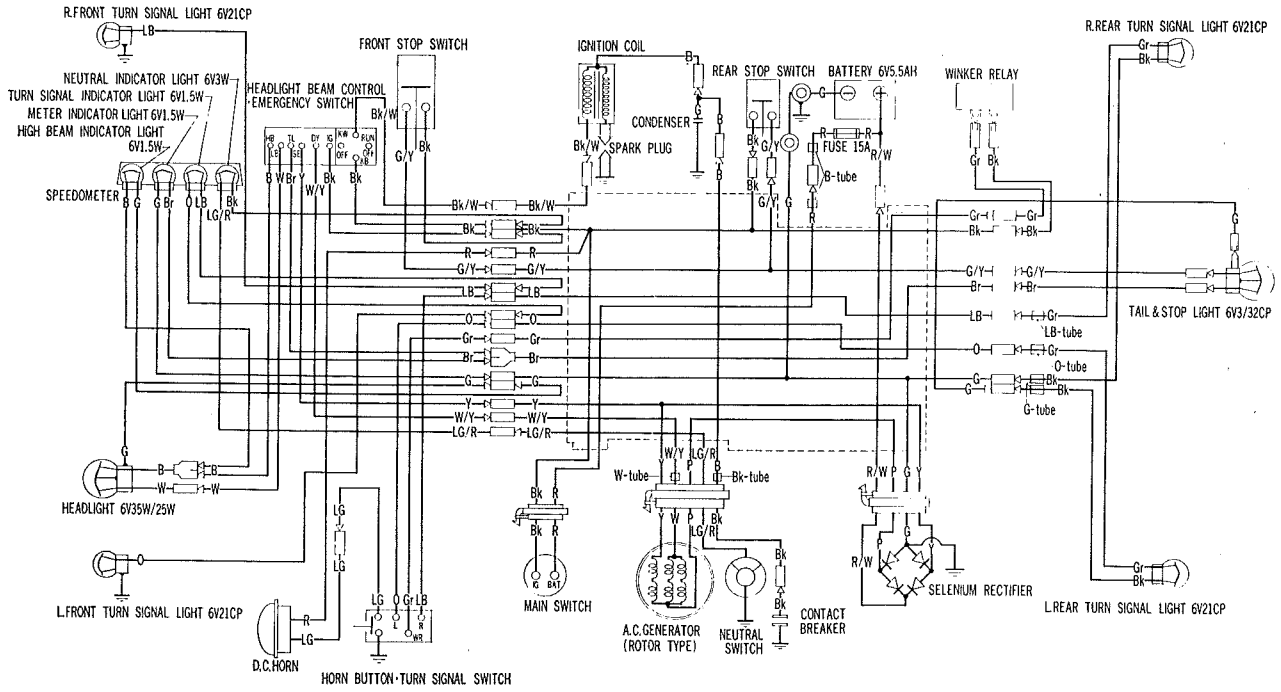

HEADLIGHT BEAM CONTROL-EMERGENCY SWITCH ARRANGEMENT		EMERGENCY SWITCH	
terminal position	IG TL LB HB DY SE	terminal position	KB KW
L	○	OFF	○
(N)	○	ON	○
H	○		
wire colour	Bk Br W B W/Y Y	wire colour	Bk Bk/W

MAIN SWITCH ARRANGEMENT	
terminal position	BAT IG
OFF	○
ON	○
wire colour	R Bk

- W.....White
- B.....Blue
- O.....Orange
- Y.....Yellow
- G.....Green
- R.....Red
- P.....Pink
- Gr.....Grey
- Bk.....Black
- Br.....Brown
- G.....Green
- LB.....Light Blue
- LG.....Light Green

ST90

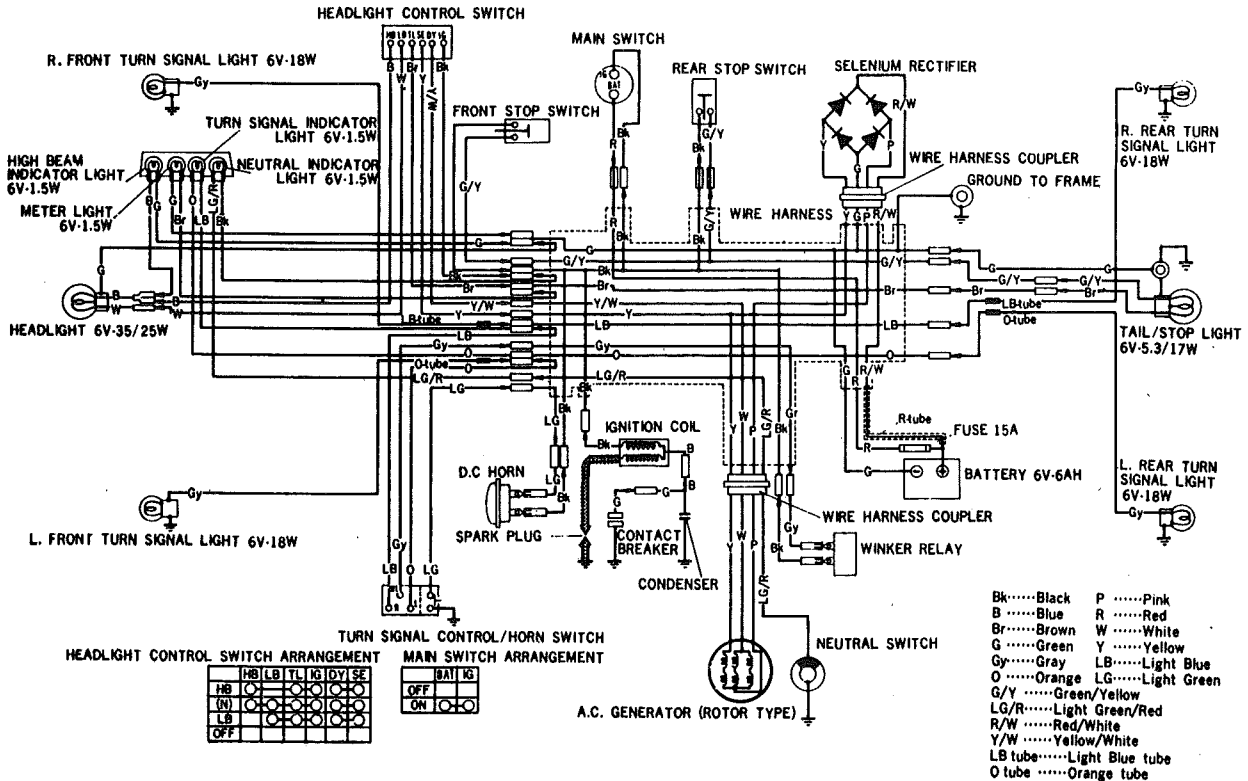

HEADLIGHT CONTROL SWITCH ARRANGEMENT	
terminal position	HB LB TL IG DY SE
OFF	○
ON	○
wire colour	Bk Br W B W/Y Y

MAIN SWITCH ARRANGEMENT	
terminal position	BAT IG
OFF	○
ON	○
wire colour	R Bk

- Bk.....Black
- B.....Blue
- Br.....Brown
- G.....Green
- Gy.....Grey
- O.....Orange
- G/Y.....Green/Yellow
- LG/R.....Light Green/Red
- R/W.....Red/White
- Y/W.....Yellow/White
- LB tube.....Light Blue tube
- O tube.....Orange tube
- P.....Pink
- R.....Red
- W.....White
- Y.....Yellow
- LB.....Light Blue
- LG.....Light Green

WIRING DIAGRAMS

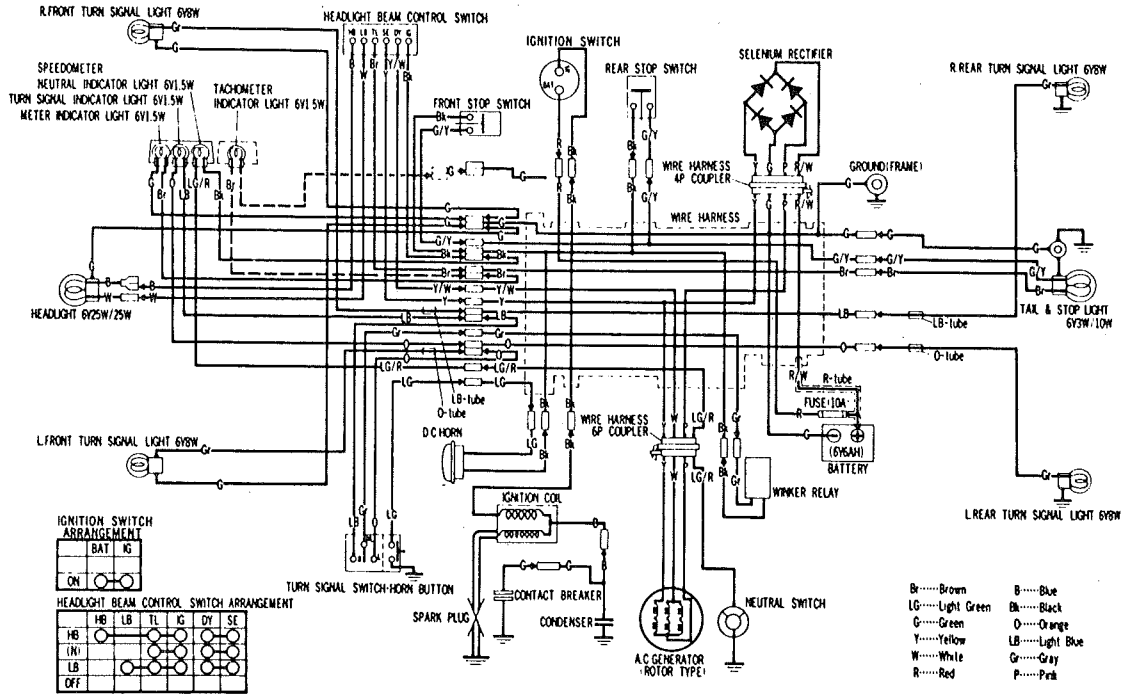

CB100K3

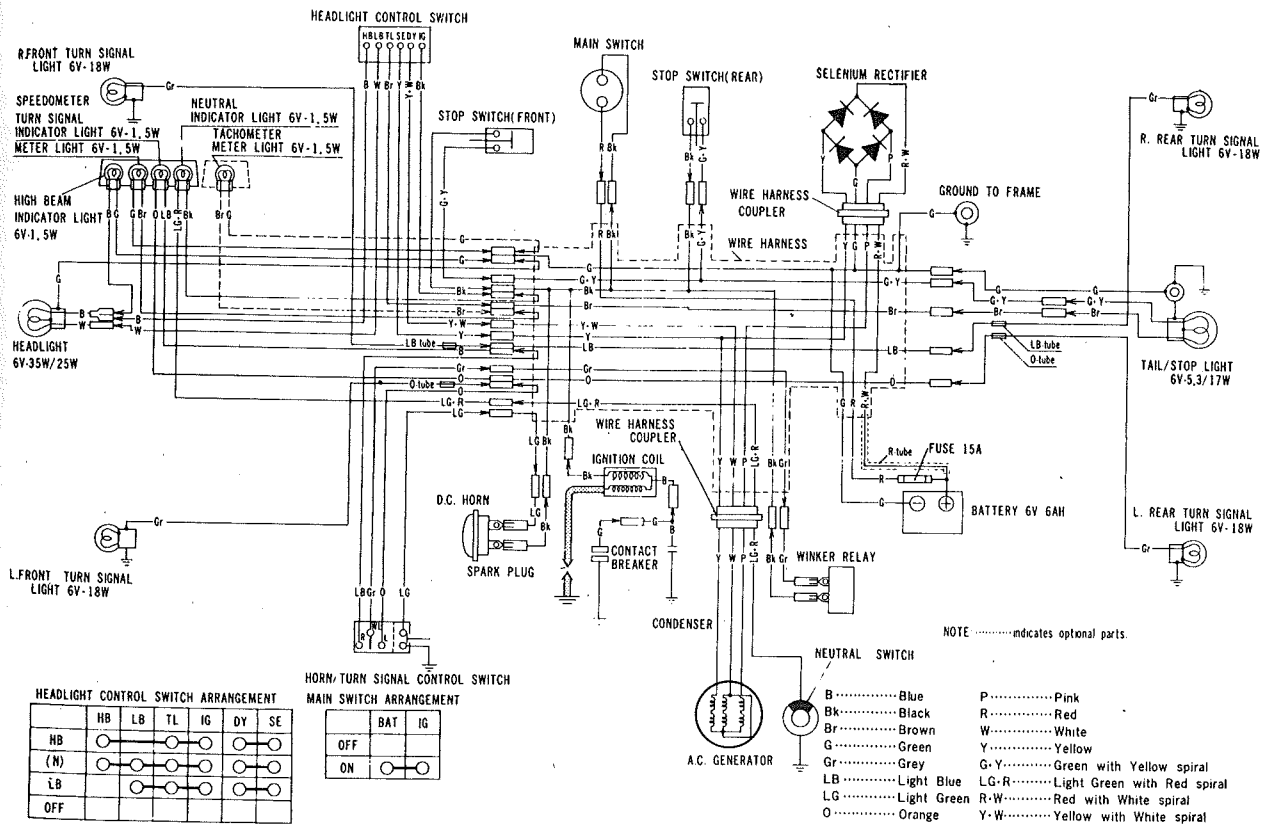

CL100/CL100S

Honda 4-Stroke Singles

WIRING DIAGRAMS

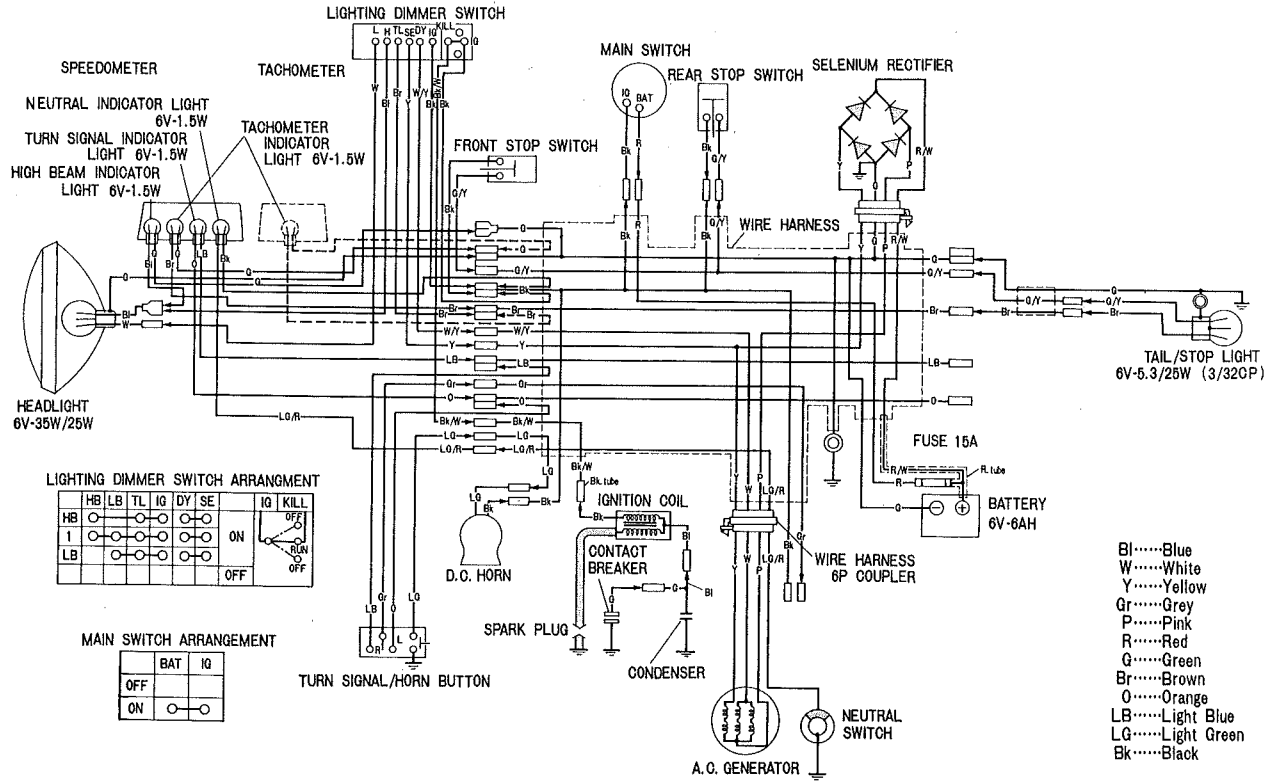

SL100

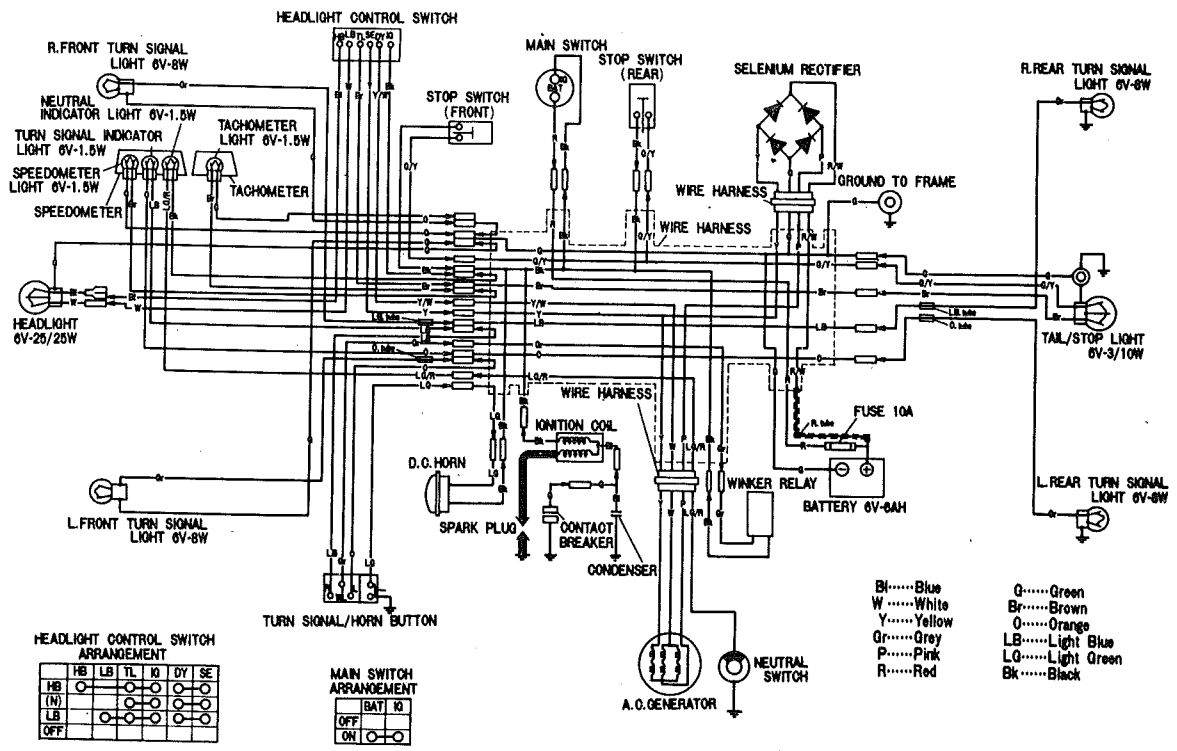

CB125S

Honda 4-Stroke Singles

WIRING DIAGRAMS

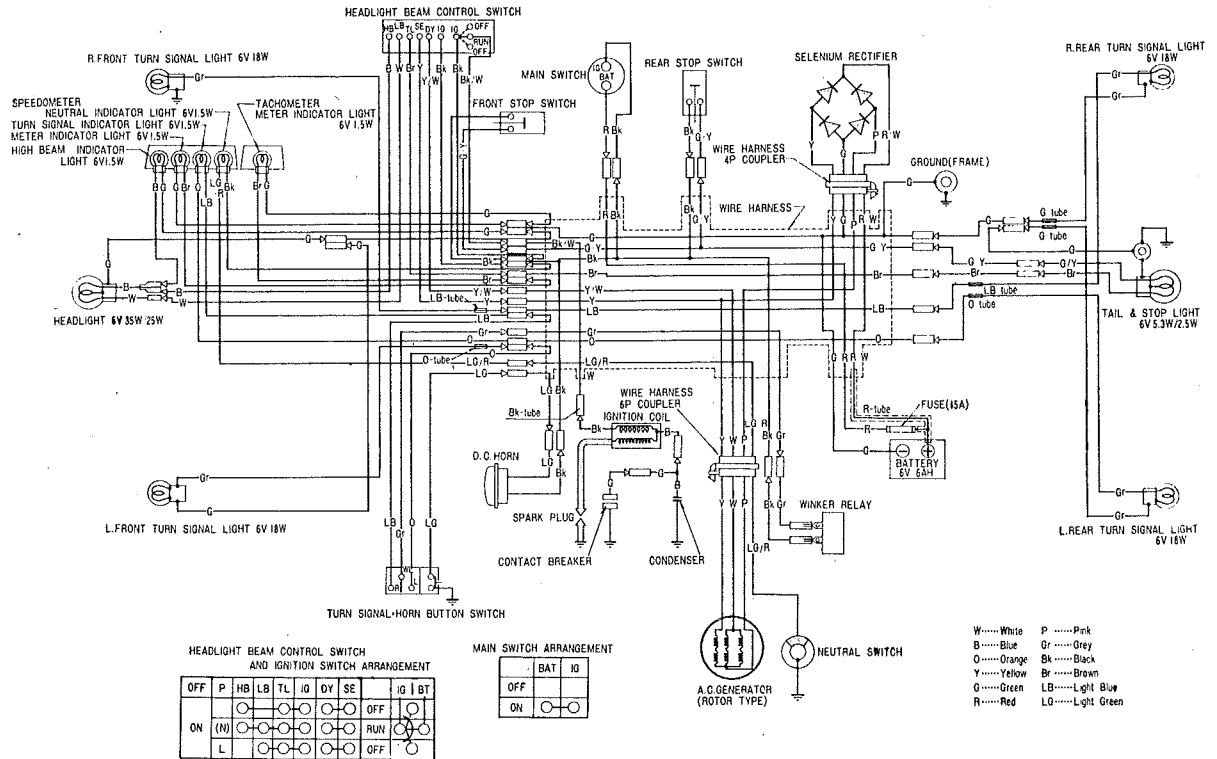

CB125S1

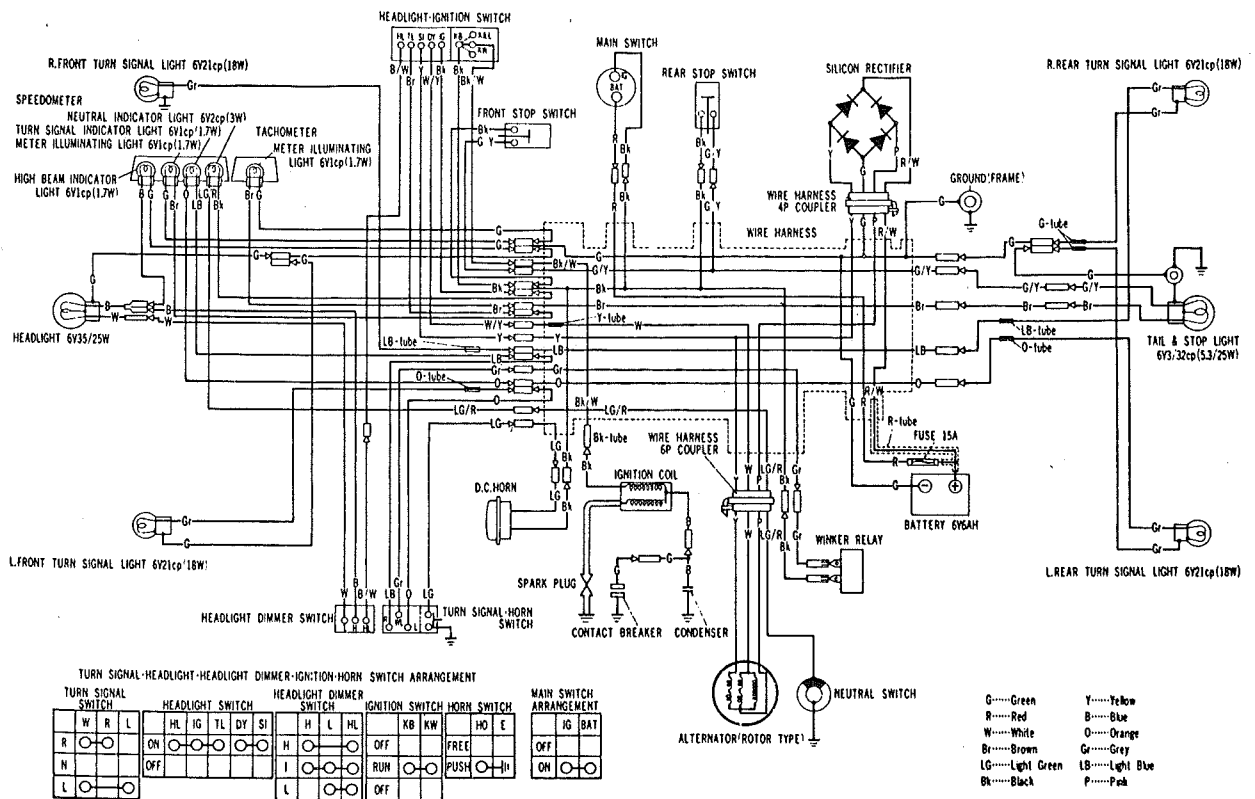

CB125S2

Honda 4-Stroke Singles

WIRING DIAGRAMS

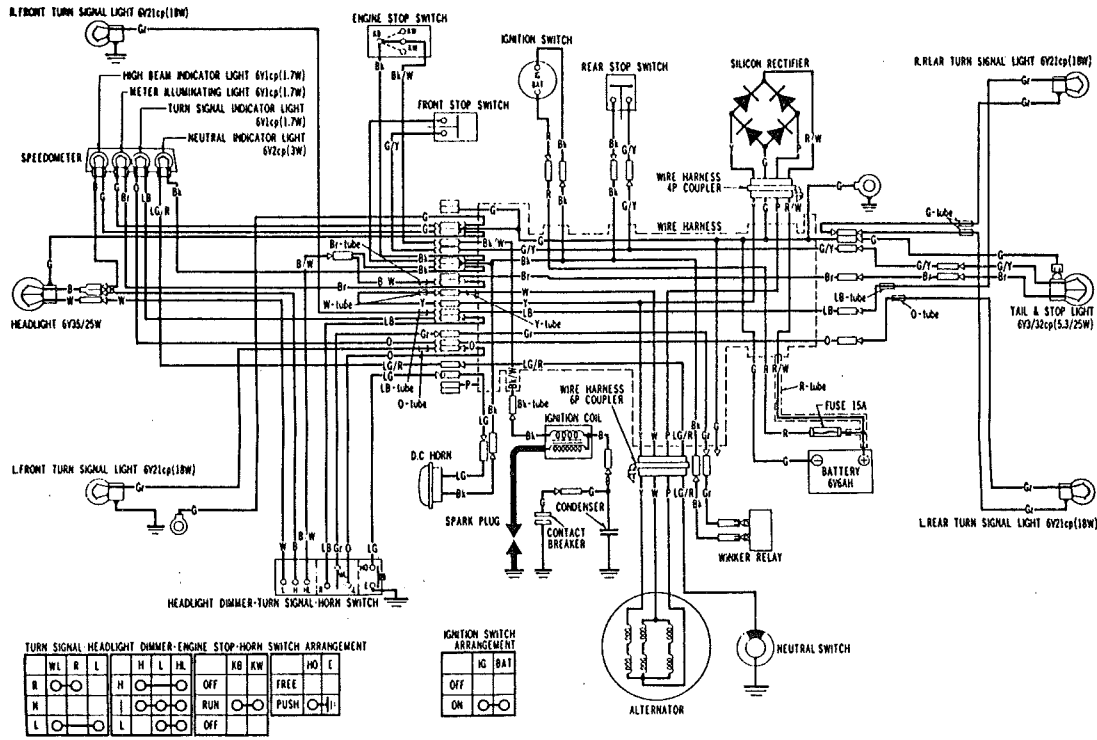

CB125S(76)

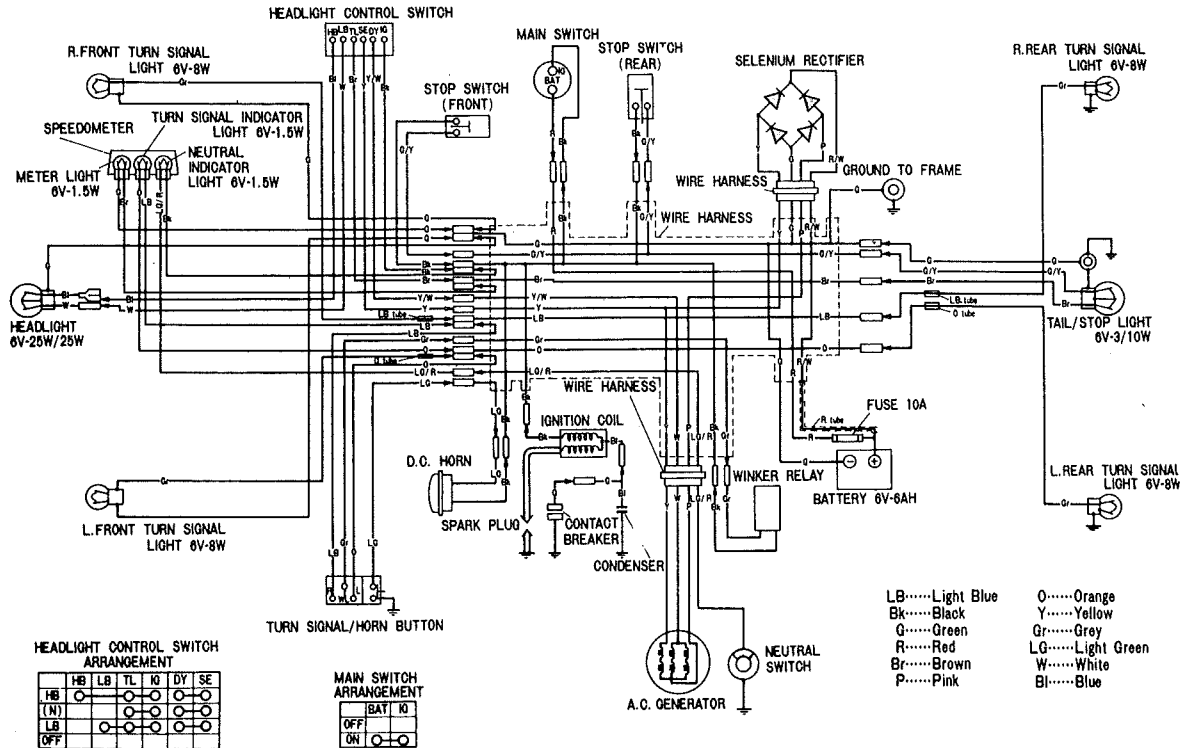

CD125S

Honda 4-Stroke Singles

WIRING DIAGRAMS

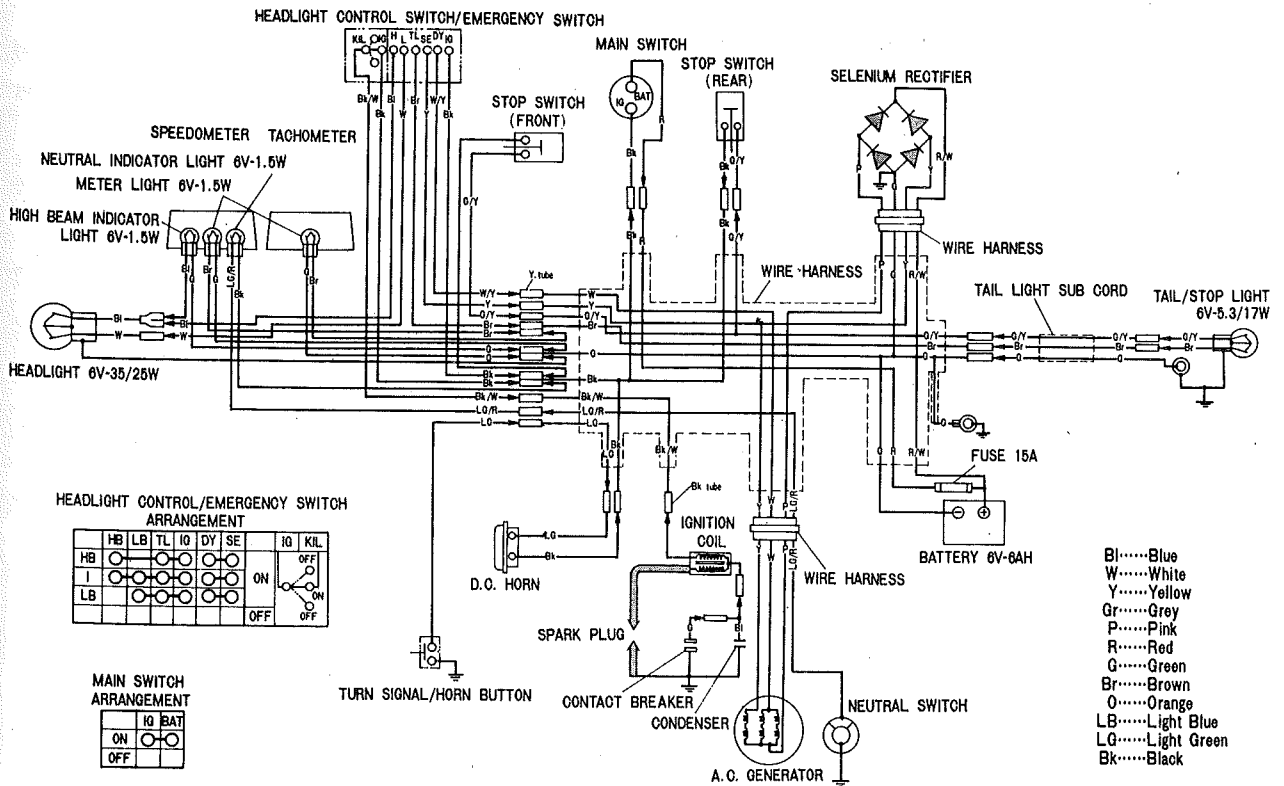
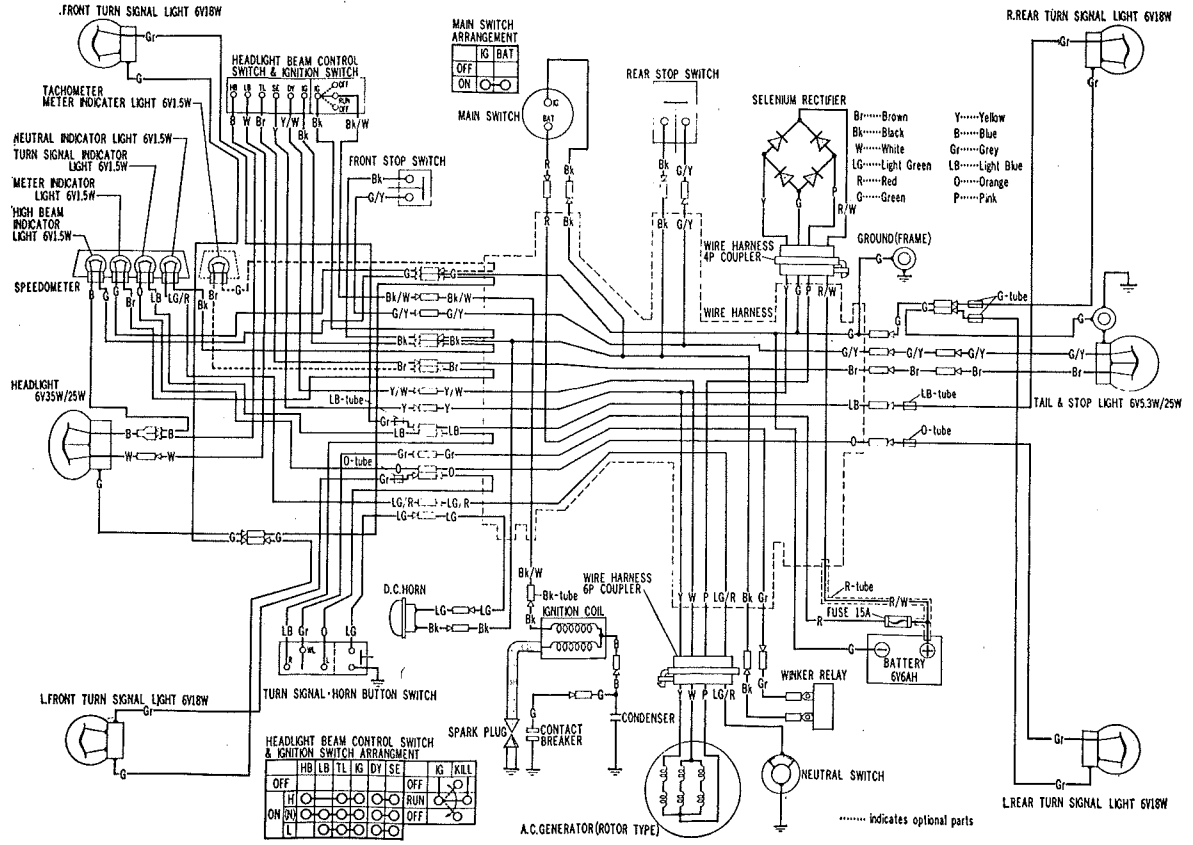

Honda 4-Stroke Singles

WIRING DIAGRAMS

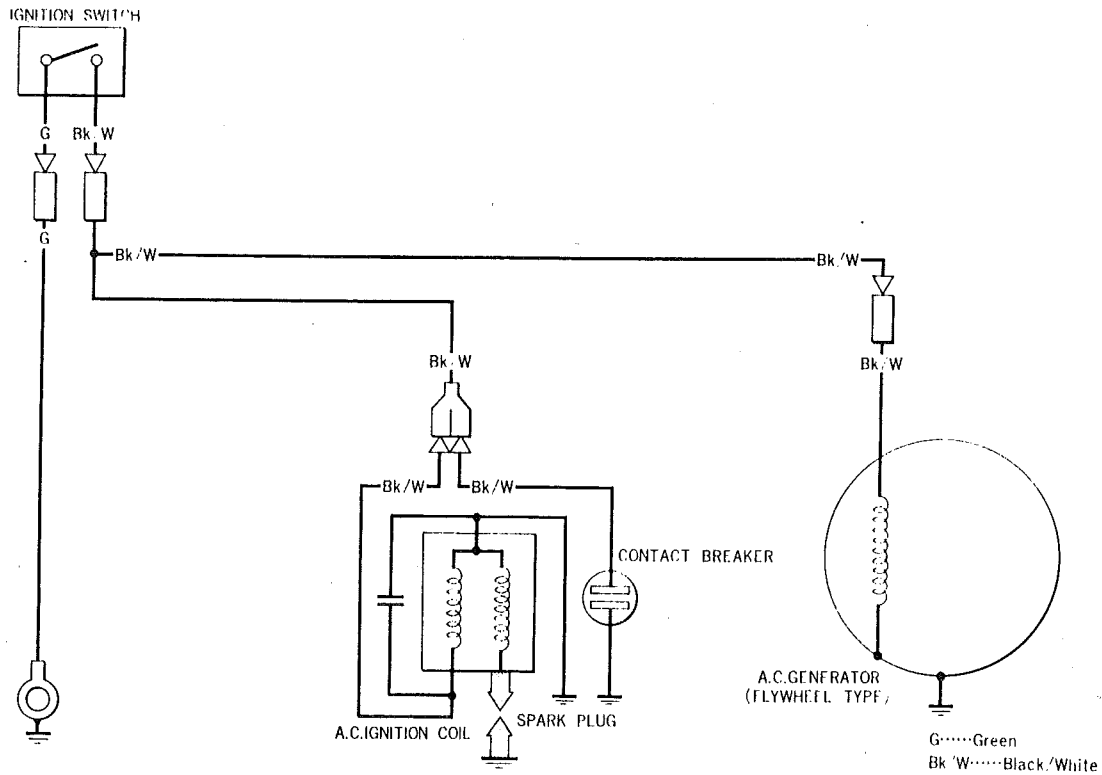

TL125

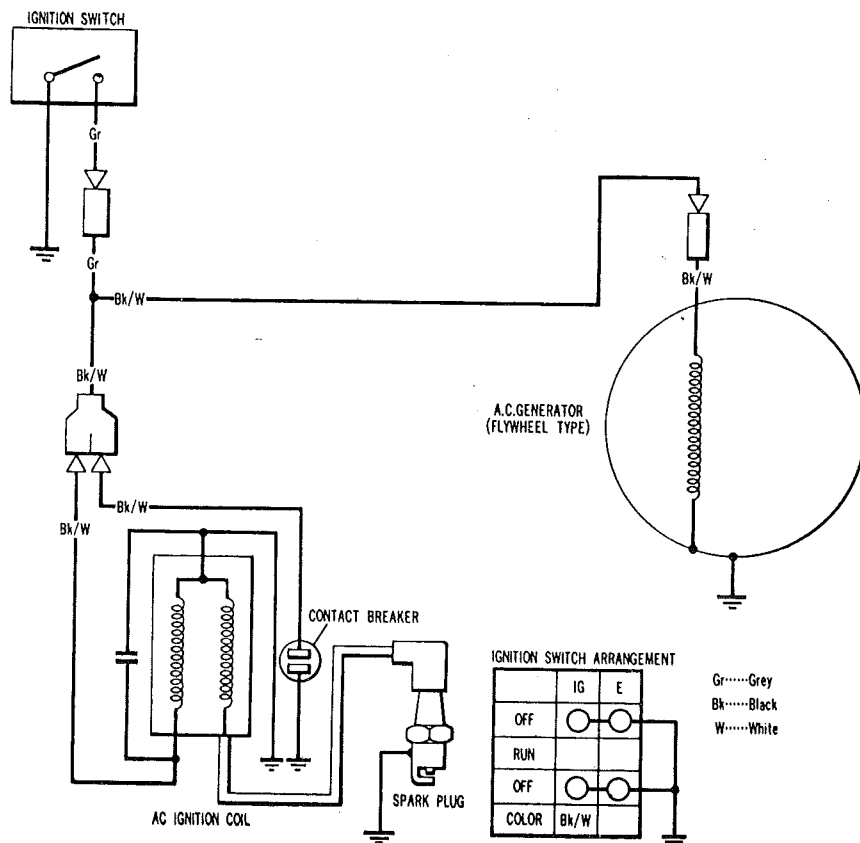

TL125K2

WIRING DIAGRAMS

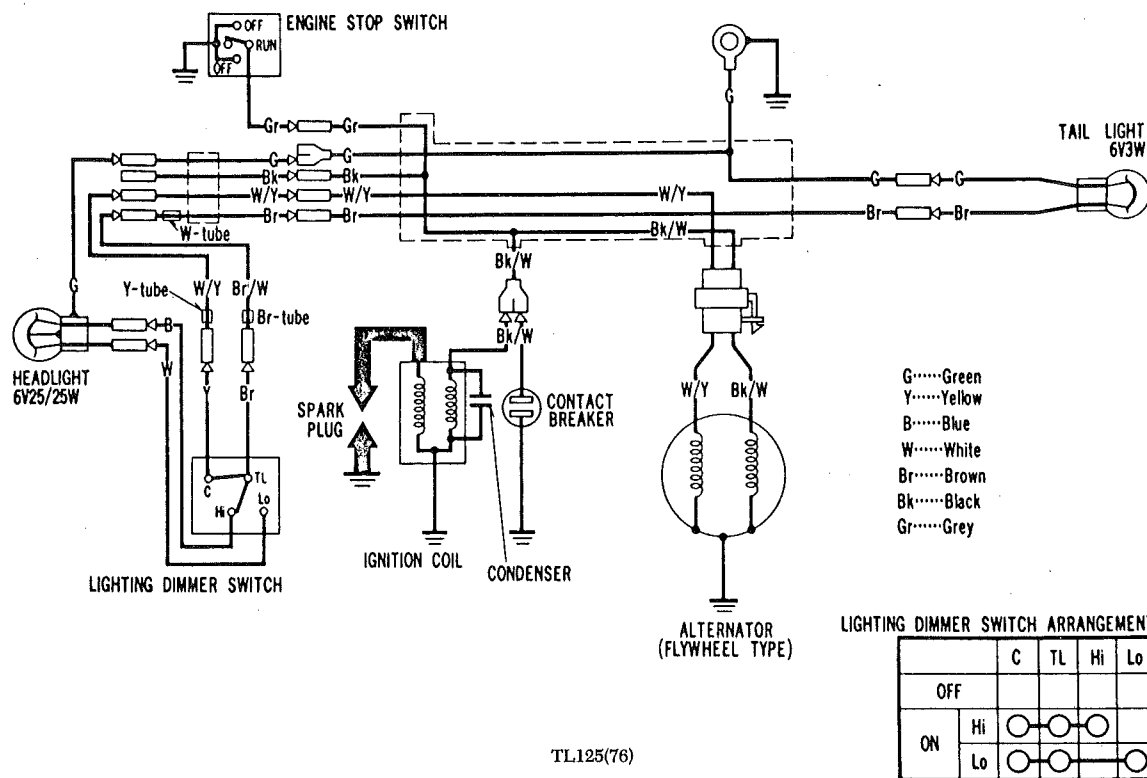

CHASSIS

WHEELS

Removal and Installation

FRONT WHEEL

1. Support the front wheel off the ground by placing a crate or another suitable object beneath the engine.

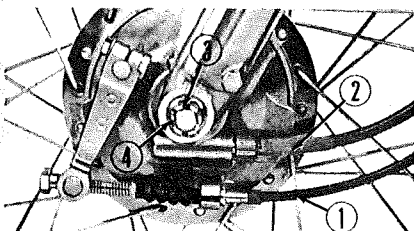

To remove the front wheel disconnect the brake cable (1), speedometer cable (2), and remove the cotter pin (3), and the axle nut (4)

2. Disconnect the front brake cable (drum brakes) and the speedometer cable at the front wheel.

3. Remove the front axle nut and pull out the axle. The wheel is now free to be removed.

4. Remove the front brake assembly (drum brakes) by pulling the front brake plate from the hub.

5. Installation is in the reverse order of removal. Be sure to locate the tab on the left fork leg into the slot in the brake plate.

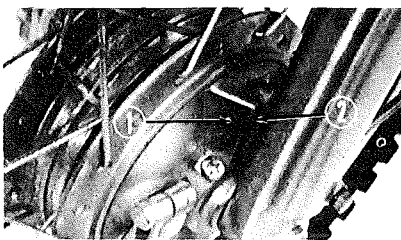

When installing the front wheel, the tab (2) must be fitted into the slot (1)

REAR WHEEL

1. Place the motorcycle on its center stand, or find some way to block the rear wheel up so that it can spin freely.

2. Remove the cotter pin, securing nut, lockwasher, and flat washer from the brake anchor at the brake plate.

3. Remove the cotter pin and axle nut from the left-side of the axle.

4. Remove the rear brake adjusting nut from the end of the brake cable and disconnect the cable from the brake lever.

5. Remove the masterlink from the drive chain. Place the masterlink on the end of the chain for safekeeping.

6. Pull the axle out from the right-side and remove the wheel assembly from the swing arm.

NOTE: Place the wheel spacers on the axle in the order that they are removed, and screw the axle nut on the axle for safekeeping.

7. To install the wheel: Hold the wheel in place and slip the axle in place from the right-side. Be sure that the spacers are in their correct locations.

Place both ends of the chain on the rear sprocket and install the masterlink with the open end of the spring clip facing opposite the direction of rotation.

8. Engage the brake anchor with the brake plate and secure with the flat washer, lockwasher, and the nut. Install a new cotter pin in the brake anchor bolt.

9. Turn the axle nut on finger-tight. Adjust the drive chain slack; the slack, measured midway between the sprockets, should be about $\frac{3}{4}$ in.

10. Slip the brake cable through the fitting in the brake lever and install the adjusting nut. Adjust the cable so that the brake pedal has 1 in. free-play before the brake shoes contact the drum.

11. Tighten the axle nut to the proper torque, which can be found in the "Chassis Torque Specifications" chart at the end of this section. Then back the nut off until a slot in the axle nut is lined up with a hole in the axle. Secure the axle nut in place with a new cotter pin.

Wheel Disassembly

FRONT WHEEL

Disc Brake

1. Remove the front wheel from the motorcycle as described previously.

CAUTION: Do not operate the brake lever when the front wheel is removed. To do so will advance the ratchet adjuster to a point where the disc will not fit between the pads when the wheel is installed. If this should happen, the caliper will have to be disassembled and the adjusting screw in the brake arm loosened. Refer to the "Front Brake" following.

Honda 4-Stroke Singles

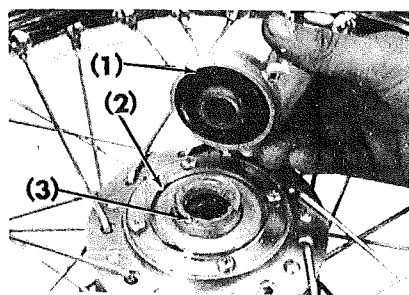

Speedometer drive housing (1), retainer cover (2), and retainer (3)

2. Remove the speedometer drive housing from the right-side of the hub.
3. Remove the side collar from the left-side of the hub.
4. Bend back the tabs on the disc nut lockplates and remove the disc nuts, lockplates, and the disc.

5. Remove the four phillips head screws from the retainer cover on the right-side of the hub. Remove the retainer cover and the retainer.

6. Unscrew the wheel bearing retainer using the factory tool No. 07910-3230100. If the factory tool is not available use a blunt punch and hammer. Take care not to distort the retainer or damage the threads in the hub. Replace the oil seal in the retainer if the lips are damaged.

7. To remove the wheel bearings use a blunt punch and hammer. Remove the bearing in the left-side of the hub first. Reach through the center of the hub and tap the inside of the bearing evenly around its circumference to remove it. Be sure that the bearing does not become cocked to one side on removal. After the first bearing has been removed, remove the spacer tube from the center of the hub. Remove the second bearing using a block of wood large enough to cover the entire bearing. If the bearings resist removal, gently heat the bearing bosses in the hub with a propane torch and then try to tap them out.

Drum Brake

1. Remove the front wheel from the motorcycle as previously described.

2. Remove the brake plate. Remove the cotter pin and washer from the upper brake pivot (if fitted). Spread the brake shoes by hand until they will clear the brake cam, remove the shoes complete with the brake springs from the plate.

3. Remove the pinch-bolt from the brake lever and remove the lever, return spring, flat washer, and dust seal. Push the brake cam out of the brake plate.

4. Remove the wheel spacer from the right-side of the hub. Remove the oil seals from the right-side of the hub and the inside of the brake plate. These seals can be pried out with a hooked tool as new seals should always be used on reassembly. However take care not to score the hub surface.

5. Using a propane torch, gently heat the area around one of the bearings. Turn the wheel assembly over, placing it on a bench so that the heated side faces down.

6. With a suitable drift and hammer, tap out the bearing. The spacer tube will

also come out after the bearing is removed.

7. Turn the wheel over, and heat the hub in the vicinity of the other bearing as was done previously. Tap this bearing out in the same manner.

REAR WHEEL

1. Remove the rear wheel from the motorcycle as previously described.

2. Remove the brake plate. Remove the pinch-bolt from the brake lever and remove the brake lever, flat washer, and the dust seal from the brake plate.

3. Remove the cotter pin and washer from the upper brake pivot if fitted. Spread the brake shoes by hand and remove them complete with their springs from the plate.

4. Push the brake cam out of the brake plate.



Removing the sprocket circlip

5. To service the wheel bearings the rear sprocket will have to be removed.

On most models the rear sprocket is secured to the hub with a large circlip. If the sprocket has nuts on it these should be loosened before tapping the sprocket from the hub. On models with a sprocket hub, the sprocket bearing is removed in the same manner as a wheel bearing. On most models an oil seal is fitted to the hub on the outside of the left wheel bearing; this seal should be pried out with a hooked tool and a new one installed upon assembly. If a bearing retainer is fitted, unscrew it with a blunt punch and hammer. Be careful not to damage the threads in the hub.

6. Using a propane torch gently heat the hub in the area around one of the bearings. Place the wheel on a bench so that the heated side is facing down.

7. With a suitable drift reach through the center of the hub and tap out the wheel bearing, be careful not to score the hub surface. The spacer tube will also come out when the bearing is removed.

8. Turn the wheel over and heat the hub in the vicinity of the other bearing as was done previously. Tap this bearing out in the same manner.

Inspection

ALL MODELS

Brakes

1. Clean all parts thoroughly in a suitable solvent, making a special effort to remove the dust and built-up dirt from the brake plate.

2. Inspect the shoes for wear. There should be at least 2.0 mm (0.08 in.) of lin-

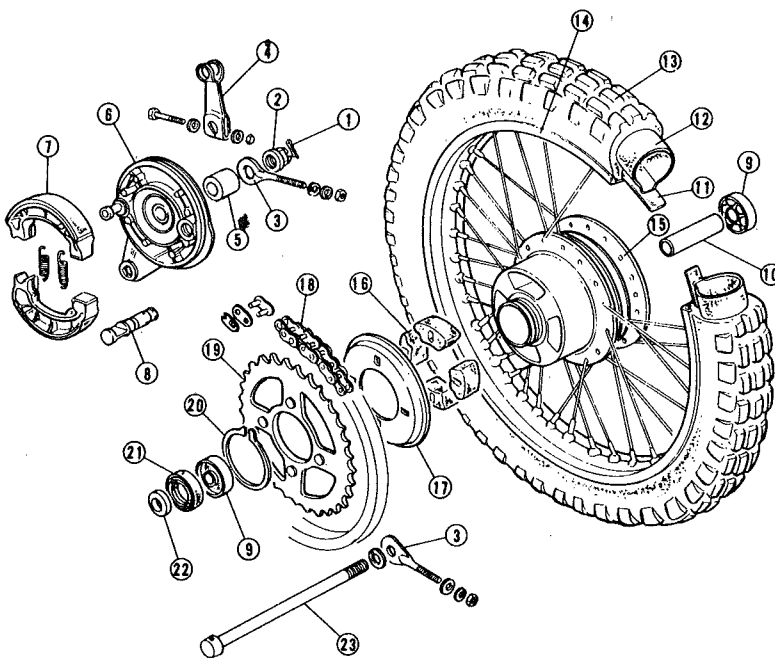

Rear wheel assembly—SL70, XR75

- | | | |
|-------------------|--------------------|-------------------|
| 1. Cotter pin | 9. Wheel bearing | 17. Damper cover |
| 2. Axle nut | 10. Bearing spacer | 18. Chain |
| 3. Chain adjuster | 11. Rim band | 19. Rear sprocket |
| 4. Brake lever | 12. Tube | 20. Circlip |
| 5. Axle spacer | 13. Tire | 21. Oil seal |
| 6. Brake plate | 14. Rim | 22. Axle spacer |
| 7. Brake shoe | 15. Hub | 23. Axle |
| 8. Brake cam | 16. Rubber damper | |

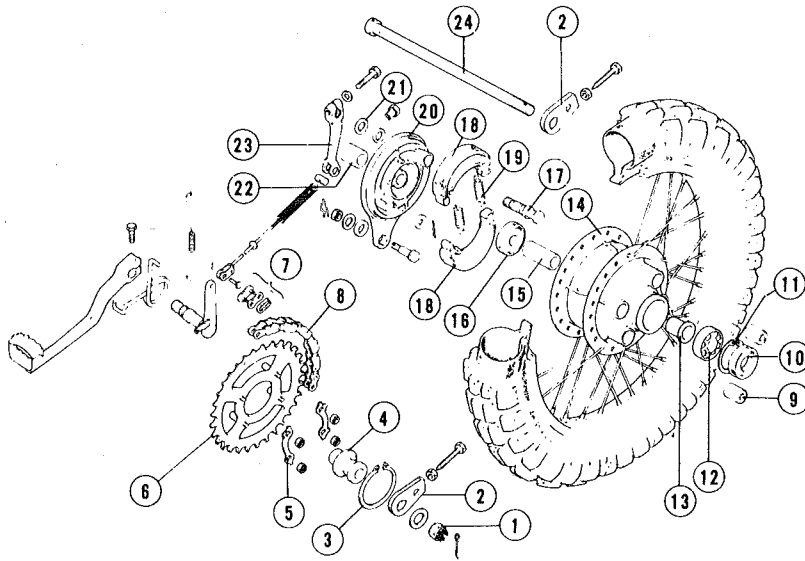

Rear wheel assembly—100, 125 cc models

- | | | |
|-------------------|--------------------|-------------------------|
| 1. Axle nut | 9. Rubber damper | 17. Brake cam |
| 2. Chain adjuster | 10. Oil seal | 18. Brake shoe |
| 3. Snap-ring | 11. Snap-ring | 19. Brake return spring |
| 4. Spacer | 12. Wheel bearing | 20. Brake plate |
| 5. Lockwasher | 13. Axle spacer | 21. Brake cam dust seal |
| 6. Sprocket | 14. Hub | 22. Spacer |
| 7. Masterlink | 15. Bearing spacer | 23. Brake lever |
| 8. Chain | 16. Wheel bearing | 24. Axle |

ing material left (measured at the lining's thinnest point) or the shoes must be replaced.

3. Inspect the linings for scoring or grooves. These may be caused by particles of dirt which enter the drum. If badly scored, the shoes should be replaced and the drum inspected closely for the same type of damage.

Be sure that the linings are free of any oil or grease. Impregnated linings must be replaced.

4. If the linings are in usable condition, rough up the surface with coarse sandpaper. Then, clean the linings with alcohol, or lacquer thinner. Clean the brake drum with the same solvent.

5. Check that the brake lever pinch-

bolt is not bent. Replace it if this has occurred. Replace the brake lever if the splines are worn or broken.

6. Inspect the splines on the brake cam. These should be in good condition. The cam must rotate freely in the brake plate passage. If it does not do so, use a fine grade of sandpaper on both the cam and the surface of the passage.

7. Check the condition of the brake springs. Replace them if weakened, rusted, or deformed.

8. Check the brake plate for cracks or fractures.

Brake Drums

1. Upon disassembly of the hub, inspect the brake drum surface for condition. The drums must be clean and free of score marks or rust.

2. Rust can be removed from the drum surface with sandpaper. Polish the surface until it is shiny, then clean it thoroughly.

3. Alcohol or lacquer thinner can be used to remove dirt or deposits from the drum.

4. The drum should be checked for concentricity. An out-of-round condition is usually noticeable as an on-off-on feeling when the brake is applied while riding. With the wheel assembly mounted on the machine, spin the wheel while applying the brake very lightly. The rubbing noise of the brake against the drum should be heard for the entire revolution of the wheel.

5. An out-of-round condition and most scoring can be removed by having the drum turned on a lathe. This operation should be entrusted to a qualified specialist with the proper equipment. Usually, the tire and wheel bearings will have to be removed so that the wheel can be chucked in the lathe. If the rim needs to be trued, have this done before any work on the drum is performed, as the action of the spokes while truing the rim may further aggravate the drum warp-
age.

Cushion Hub

When the sprocket and the drive flange are removed, check the condition of the rubber dampers in the hub. Replace them if they are worn, cracked, or hardened. The dampers must not allow the drive flange to move more than 1/2 in. in the hub. This reading is taken by placing the flange in the hub and noting the total movement of the rim of the flange relative to the rim of the hub in the plane of wheel rotation. If movement exceeds 1/2 in., the dampers should be replaced.

Wheel Bearings

1. Clean the bearings, and spacer tube in a suitable solvent, removing all of the old grease. Clean out the hub as well.

2. Check the bearing bosses in the hub for scuffs, cracks, or distortion. If they are in any way damaged, the hub must be replaced.

3. Check the condition of the spacer tube, and replace if damaged.

4. Bearing condition is very important. Check the balls themselves for pitting, wear, or rust.

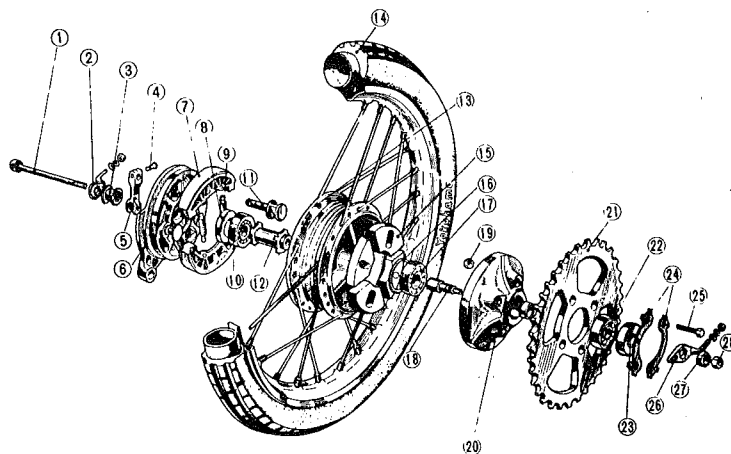

Rear wheel assembly—90 cc models

- | | |
|--------------------------|--------------------------|
| 1. Axle | 15. Rubber dampers |
| 2. Chain adjuster | 16. O-ring |
| 3. Side collar | 17. Wheel bearing (6301) |
| 4. Bolt | 18. Axle sleeve |
| 5. Brake lever | 19. Nut |
| 6. Brake plate | 20. Sprocket hub |
| 7. Brake shoe | 21. Rear sprocket |
| 8. Oil seal | 22. Hub bearing (6203Z) |
| 9. Brake spring | 23. Oil seal |
| 10. Wheel bearing (6301) | 24. Lockplate |
| 11. Brake cam | 25. Sprocket bolt |
| 12. Bearing spacer tube | 26. Chain adjuster |
| 13. Hub | 27. Axle sleeve nut |
| 14. Tire | 28. Axle nut |

Honda 4-Stroke Singles

5. Apply a few drops of light oil to the bearing and spin it. The bearing must rotate smoothly and freely. Any roughness or binding in rotation will necessitate new bearings.

6. Place the bearing on a flat surface. Place your fingers on the outer bearing race to hold it steady. Attempt to move the inner race back and forth. In a good bearing, the race will spin, but not move in any other direction. If it does, the bearing must be replaced.

7. Note that the bearings must be replaced in pairs.

Wheel Assembly

ALL MODELS

Assembly is in the reverse order of disassembly; however, note the following points:

1. Obtain a good grade of wheel bearing grease to lubricate the wheel bearings.

2. Pack the wheel bearings until they are completely filled.

3. Drive one of the bearings into its seat. Put a quantity of wheel bearing grease into the hub. Install the retainer if so equipped. Install the spacer tube and drive the other bearing into its seat. The sealed surface of the bearing must face the outside of the hub, where applicable.

Bearings should be installed with a block of hardwood as a drift. Do not strike the inner race of the bearing when installing it. Tap around the outer race until the bearing is straight in the hub, then drive it straight in.

NOTE: When a bearing retainer is fitted, the bearing with the retainer should be installed first. Then install and tighten the retainer, spacer tube, and the other bearing.

4. Replace all of the oil seals with new ones. Like the bearings, the seals should be pressed straight in.

5. Coat the surface of the brake cam with chassis grease before installing it into the brake plate.

6. Lubricate the brake shoe pivot points with chassis grease. Take care not to allow any grease to come into contact with the surface of the brake shoes or drums.

7. Line up the slots in the speedometer gear with the slots in the wheel hub.

8. Install the brake lever on the brake cam so that the punch marks on the brake lever and the brake cam are lined up.

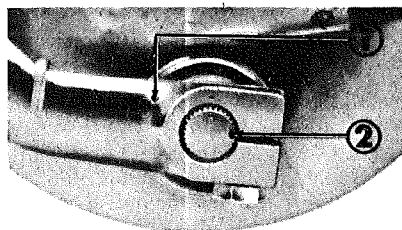

When installing the brake levers, note that the punch mark on the lever (1) must align with that on the brake cam (2)

Front Disc Brake

DISASSEMBLY

1. Slide the rubber boot on the lower

part of the brake cable up on the cable to expose the brake cable adjuster in the caliper body. Loosen the locknut on the adjuster, and screw the adjuster into the caliper body as far as it will go.

2. Remove the three 6 mm bolts from the caliper cover, and remove the cover and the ratchet fixing spring. Pull the ratchet adjuster from the brake arm. Remove the brake arm, and disconnect the brake cable.

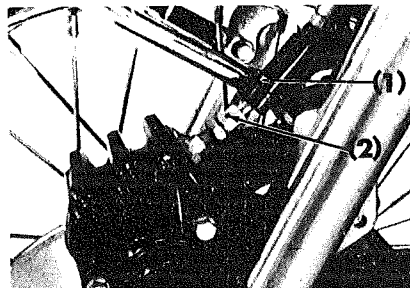

Slide the rubber boot (1) up to expose the cable adjuster (2)

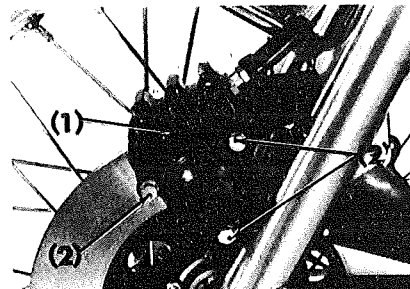

Remove the caliper cover bolts (2), and remove the cover from the caliper body (1)

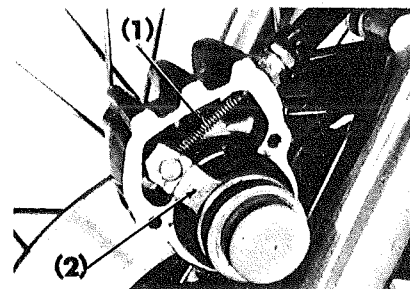

Disconnect the brake cable (1) from the brake arm (2)

CAUTION: Cover the brake arm in a clean cloth or a plastic bag to prevent dirt from entering the inside of the mechanism. The brake arm should not be disassembled; if defective, it should be replaced.

3. The thrust guide plate can now be removed from the caliper body. To remove the disc pads, screw one of the caliper cover bolts (6 mm) into the threaded hole in the back of pad A (the pad to the outside of the disc). Using the bolt, pull the pad out of the caliper. Remove the front wheel as described at the beginning of this section. Pad B (pad to the inside of the disc) can be removed by pushing on the lockpin on the back of the caliper body. Remove the pad from the left-side of the caliper.

4. Remove the two 6 mm and one 8 mm caliper mounting bolts from the

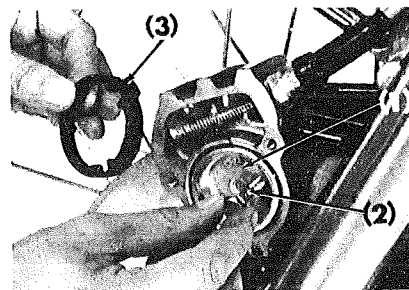

Remove the thrust guide plate (3), and screw a 6 mm screw (2), into the back of pad A (1), to pull the pad from the caliper

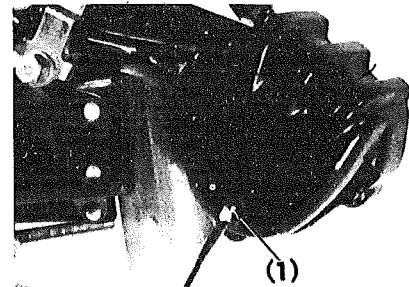

Push on the lockpin (1) to remove pad B from the caliper

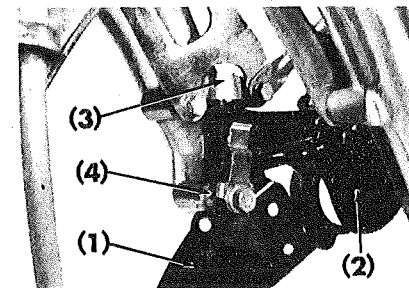

Disc cover (1), caliper (2), caliper joint (3), and caliper pivot pin (4), can be removed after the mounting bolts are removed

left fork leg. Remove the disc cover, caliper body, caliper joint, and caliper pivot pin.

INSPECTION

1. Inspect the brake pads for wear. If either pad is worn past the red wear limit line, replace both pads.

2. If the pads are scored they should be replaced. Minor score marks can be removed with sandpaper; however, take care to sand the pads flat and parallel to the disc surface.

3. Inspect the condition of all O-rings. Replace any which are damaged.

ASSEMBLY

1. Install an O-ring on the caliper pivot pin and apply some chassis grease to the pin. Slip the pin through the caliper and install the remaining O-ring on the top of the pin. Slip the caliper joint over the end of the pin. Install the caliper assembly to the left fork leg, locating the disc cover to the lower (8 mm) mounting bolt. Be sure that the pivot pin is installed correctly and that the lockplate is in place on the lower mounting bolt.

2. Place a small amount of silicon grease (KS62M) on the back of pad B, and

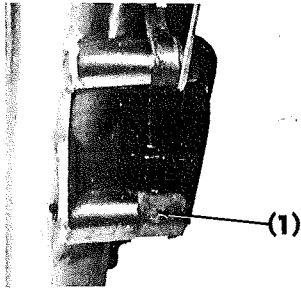

Upon assembly be sure that the pivot pin (1), is installed correctly

install pad B into the right-side of the caliper, locating the lockpin through the hole in the back of the caliper.

3. Install the front wheel.

4. Place a new O-ring on pad A and coat the entire circumference of the pad with a thin layer of silicon grease (KS62M). Install the pad into the caliper aligning the punch marks on the pad and the caliper body as the pad is installed.

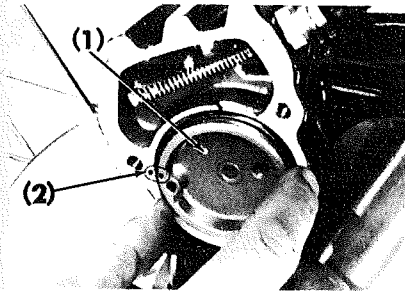

When installing pad A (1), be sure that the punch marks (2), on the pad and the caliper align

5. Install the thrust plate guide into the caliper. Connect the brake cable to the brake arm. With a small screwdriver, turn the adjusting screw in the center of the brake arm counterclockwise until resistance is felt. The adjusting screw should turn freely. Install the brake arm.

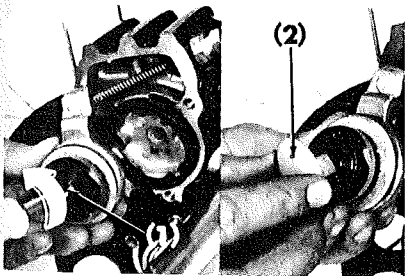

Turn the adjusting screw (1) counterclockwise until resistance is felt, then install the ratchet adjuster (2) into the brake arm

6. Install the ratchet adjuster, locating it into the slot in the adjusting screw. Install a new caliper cover gasket, the caliper cover, and ratchet fixing spring. Secure the cover with the three cover bolts.

7. Screw the adjusting bolt out of the caliper body all the way. Then screw in the adjuster until there is slack in the cable. From this position turn the adjuster out another 2 to 3 turns.

8. Operate the hand lever about 10 times. The lever should automatically adjust itself to the proper free-play of 20-30

mm (0.8-1.2 in.) measured at the tip of the lever.

9. After adjustment is correct, slip the rubber boot over the cable adjuster. Raise the front wheel off the ground and check that the wheel spins freely.

PAD REPLACEMENT

1. The procedures for removing and installing the pads for replacement are given under "Front Disc Brake—Disassembly" and "Assembly." However, Step 4 under "Disassembly," and Step 1 under "Assembly" can be omitted.

CABLE REPLACEMENT

1. Remove the cover from the left-side of the caliper. Screw the cable adjuster into the caliper body as far as possible. Remove the brake arm with the ratchet adjuster in place and disconnect the cable from the brake arm. Screw the adjuster out of the caliper body and remove the cable from the caliper.

2. Remove the rubber boot from the hand lever, disconnect the cable from the lever, and remove the cable.

3. Connect the new cable to the hand lever and replace the rubber boot.

4. Screw the cable adjuster on the new cable all of the way into the caliper body. Connect the cable end to the brake arm and install the brake arm into the caliper body. Install the caliper cover. Turn the cable adjuster out of the caliper until there is no slack in the cable and then turn the adjuster out another 2 to 3 turns.

5. Operate the hand lever about 10 times. The lever should automatically adjust itself to the proper free-play of 20-30 mm (0.8-1.2 in.), measured at the tip of the lever.

BRAKE DISC SERVICE

The brake disc normally requires no service of any kind. However, if the disc becomes scored for any reason, it should be replaced and a new set of pads should be installed. A badly scored disc will reduce the effectiveness of the brake and shorten pad life considerably. If the front brake lever oscillates or fluctuates when the brake is applied at speed, the indication is that the brake disc is warped or bent. Check the run-out of the disc with a dial indicator and replace it if run-out exceeds 0.012 in. (0.3 mm). To replace the disc:

1. Remove the front wheel.

2. Bend back the locktabs, unscrew the six nuts, and remove the disc from the hub.

3. Mount the new disc on the hub and tighten the nuts evenly, using new locktabs to secure the nuts.

4. Examine the brake pads and replace them if they are close to the limit of wear or have worn in an unusual pattern.

FRONT FORKS

Removal

MINI-TRAIL FORK

The mini-trail fork does not contain oil.

1. Remove the front wheel.

2. Remove the front fender.

3. Remove the bolt at the top of each fork leg and the steering stem nut.

4. The fork leg can be removed from each side after unscrewing the front fork guide cap with a chain wrench.

ALL OTHER MODELS

1. Loosen the fork filler caps located at the top of each fork leg.

2. Support the front wheel off the ground by placing a crate or another suitable object beneath the engine.

3. Remove the front wheel. Remove the fender.

4. Loosen the pinch-bolts on the upper and lower triple clamps, and remove the fork legs one at a time by pulling them straight down. If the fork legs resist removal, spread the lower triple clamp with a wedge and tap the fork leg out with a soft faced mallet.

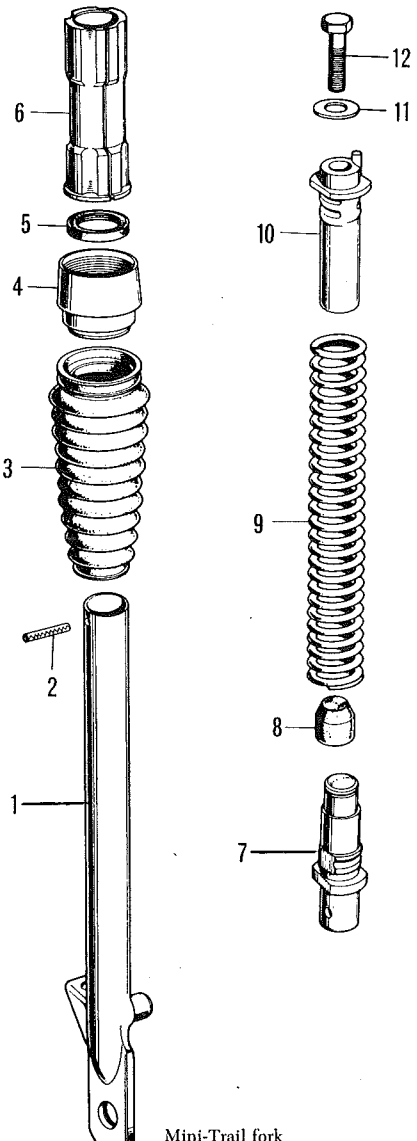

- 1. Fork slider
- 2. Pin
- 3. Boot
- 4. Fork guide cap
- 5. Dust seal
- 6. Fork guide pipe
- 7. Lower holder
- 8. Piston
- 9. Fork spring
- 10. Upper holder
- 11. Washer
- 12. Fork cap bolt

Honda 4-Stroke Singles

Disassembly

MINI-TRAIL FORK

1. Fix the fork assembly in a vise by the upper holder. Strike the spring with a drift to remove it from the upper holder. Do not damage the upper holder as this is done.

2. Separate the spring from the lower holder in the same manner as above.

3. Using a small drift, push out the pin which secures the under holder and piston to the fork slide pipe.

TL125

The procedure is given for one fork leg, but it applies to both.

1. Remove the filler cap from the top of the fork tube and pour the oil into a suitable container to be disposed of.

2. Remove the spring(s) from the top of the tube.

3. Turn the fork upside-down and rest it on a block of hardwood. With an impact driver and the proper bit remove the allen bolt from the bottom of the slider. These bolts are installed with thread locking compound and trying to remove them without an impact driver will result in rounding the head of the bolt.

4. When the bolt is removed from the bottom of the slider, the damper rod complete with piston ring, and the rebound spring can be removed from the top of the fork tube.

5. The tube can now be pulled out of the slider. The piston will remain in the slider. Once the tube is pulled out the oil seal in the slider will have to be replaced.

6. Remove the dust cover and snapping from the top of the slider and pry out the oil seal with a hooked tool. The pin wrench from the Honda tool kit may be used by slipping the hooked end under the seal and tapping the handle with a hammer. A strip of copper or other soft metal can be used between the top of the slider and the handle of the wrench to protect the slider.

ALL OTHER MODELS

The procedure is given for one fork leg, but it applies to both.

1. Remove the filler cap from the top of the fork leg and pour the oil into a suitable container to be disposed of. Remove the fork spring (pre-76).

2. Remove the dust seal, snap-ring, and washer from the top of the slider. Grasp the slider in one hand and the fork tube in the other and pull them apart with a sharp jerk. Remove the fork spring (76).

3. Remove the circlip from the bottom of the fork tube, then the piston, two circlips, the sliding bushing and oil seal.

Inspection

ALL MODELS EXCEPT MINI-TRAIL

1. Wash all metal parts in a solvent and dry.

2. Inspect the fork slider for cracked, broken, or distorted axle brackets, worn inner bore surfaces, damaged threads, or dents which have affected the inner bore. Replace the slider if defective in any of the above ways.

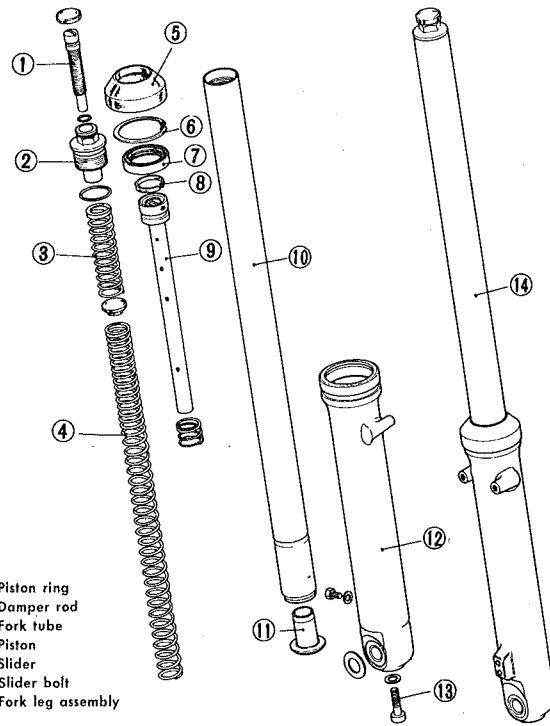

- | | |
|-----------------------|-----------------------|
| 1. Spring adjuster | 8. Piston ring |
| 2. Fork filler cap | 9. Damper rod |
| 3. Fork spring, short | 10. Fork tube |
| 4. Fork spring, long | 11. Piston |
| 5. Dust cover | 12. Slider |
| 6. Snap-ring | 13. Slider bolt |
| 7. Oil seal | 14. Fork leg assembly |

TL125 front fork

3. Inspect the fork tubes for condition: the chrome plating must be intact throughout. Check for damaged threads, and worn or scuffed inner or outer surfaces. Check the tubes for straightness. This is done by placing the tubes in a set of V-blocks and checking the run-out with a dial gauge. If the tube is bent more than 0.060 in. as indicated by the gauge, it must be replaced.

4. TL125 only: Inspect the piston ring for wear or scoring.

5. Check the filler cap O-ring for cracks or any other signs of wear; replace it if damaged.

6. Check the general condition of the fork springs. Replace any which are

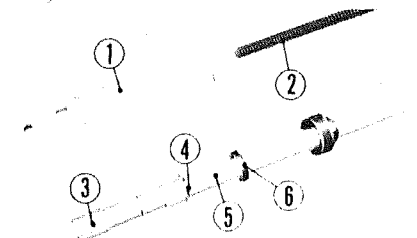

Internal fork spring components: fork slider (1), spring (2), piston (3), sliding bushing (4), fork tube (5), slider oil seal (6)

badly rusted, have collapsed coils, etc. Compare the lengths of corresponding

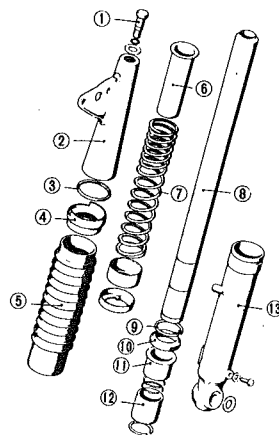

Slider bushing fork used on most models

- | | |
|-----------------------|--------------------|
| 1. Filler cap | 8. Fork tube |
| 2. Headlight brackets | 9. Circlip |
| 3. Gasket | 10. Oil seal |
| 4. Bezel ring | 11. Slider bushing |
| 5. Fork boot or cover | 12. Piston |
| 6. Spring guide | 13. Fork slider |
| 7. Fork spring | |

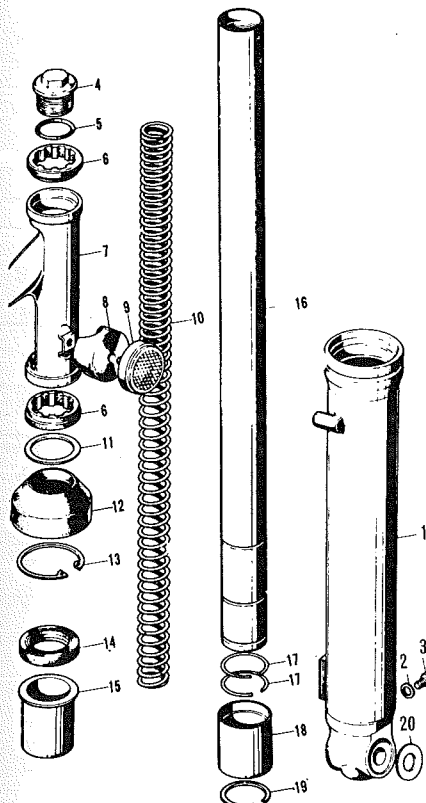

Internal fork—spring type

- | | |
|----------------------|--------------------|
| 1. Fork slider | 11. Washer |
| 2. Gasket | 12. Dust seal |
| 3. Drain plug | 13. Circlip |
| 4. Filler cap | 14. Oil seal |
| 5. O-ring | 15. Slider bushing |
| 6. Cushion | 16. Fork tube |
| 7. Headlight bracket | 17. Circlips |
| 8. Reflector base | 18. Piston |
| 9. Reflector | 19. Circlip |
| 10. Fork spring | 20. Axle washer |

springs. They should be of approximately equal length. If the springs differ in length by more than 1/4 in., both springs should be replaced.

7. All except TL125: Inspect the inside surfaces of the piston and sliding bushing for signs of wear or score marks. Replace as necessary. Place the sliding bushing on the fork tube and check for excessive play. The bushing should be a close fit.

8. Coat all parts with ATF before assembly. New oil seals must always be used.

MINI-TRAIL FORK

1. With the fork assembled, compress the fork and check for proper operation. Note any noise and correct the condition causing it.

2. Compare the free-length of the springs. If the springs differ in length by more than 1/4 in., both should be replaced.

Assembly

TL125

1. Be sure that the piston is in the slider. Lubricate the new oil seal with ATF and install it into the top of the slider. Place a block of hardwood over the seal and drive it straight into the slider as far

as possible. Then place the old seal on top of the new one and drive them in until the new one clears the snap-ring groove in the slider. Take out the old seal. Be sure that the new seal is straight in the slider. The distance from the top of the oil seal to the snap-ring groove should be the same all around the seal. Install the snap-ring. Lubricate the lips of the seal.

2. Install the rebound spring and damper rod in the fork tube. Carefully install the slider on the tube. Replace the fork springs and cap temporarily. Turn the fork upside down and install the bolt in the bottom of the slider. The threads of this bolt should be coated with thread locking compound.

3. Fit the drain plugs; be sure to install the gaskets.

4. Remove the cap and fill the forks with the proper amount of ATF. Note that the amount added to rebuilt forks will be slightly more than for a normal fork oil change.

5. Refit the fork tubes through the triple clamps. The top of the fork tube should be even with the top of the upper triple clamp.

6. Tighten the pinch-bolts on the lower triple clamp, and then tighten the fork filler caps and the pinch-bolts on the upper triple clamp, in that order.

7. Fit the front wheel and check the operation of the forks.

8. Adjust the forks by means of the adjusting screws at the top. Turning the screws in will stiffen the suspension and vice versa.

MINI-TRAIL FORK

1. Assembly is in the reverse order of the disassembly, however, note the following points:

a. When the fork leg is assembled, the locating pin on the upper holder must be perpendicular to the axle mounting lug on the slide pipe;

b. Secure the upper holder and piston to the fork slide pipe with the pin. Coat the upper and lower holders with a thin coat of grease and install the spring;

c. Fit the forks to the steering stem, noting that the locating pin on the top of the fork leg must fit into the slot in the top of the steering fork.

ALL OTHER MODELS

1. Install a new oil seal on the fork tube. Be sure to lubricate the seal with ATF before placing it on the tube.

2. Install the sliding bushing on the tube with the flange on the bushing facing the top of the tube. Install the two circlips, piston, and bottom circlip. All of the circlips must be a snug fit on the fork tube; if not replace them. Slide the fork spring into the tube from the bottom.

3. Place the fork tube into the slider and drive the oil seal into its seat in the top of the slider. Replace the washer, snap-ring, and dust seal.

4. Fill the fork leg with the proper amount of ATF. Replace the top washer, O-ring, and filler cap.

Leading Link Type Forks

DISASSEMBLY

1. Remove the front wheel.

2. Remove the 6 mm lockpin and the 7 mm locknut, then remove the front cushion joint washer and joint rubber. The front cushion and suspension arm can be removed as a unit by removing the front arm pivot bolt and the hex bolt.

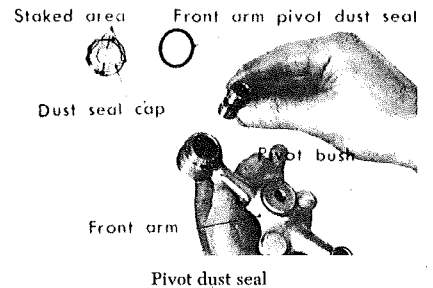

3. Remove the front arm rebound stopper by removing the 8 mm hex nut and bolt.

4. Separate the front cushion and the front suspension arm by removing the 8 mm hex nut and the front cushion lower securing bolt. Take care not to lose the front cushion lower dust seal cap, seal, and spacer collar. The dust seal can be removed by unlocking the staking.

5. The suspension unit is now ready to be dismantled. The lower portion of the cushion is a sealed unit which cannot be rebuilt, and which must be replaced if weak or damaged. Disassemble the cushion by removing the locknut and spring. The spring guide, seat, stopper rubber, and outer collar are now free to be removed.

INSPECTION

1. Clean all parts in a suitable solvent and blow them dry. The dust seals should be replaced as a matter of course.

2. Inspect the damper unit for oil leaks, warpage, or inefficient damping characteristics, and replace them if necessary.

3. Inspect the suspension and fork components for a worn or damaged condition and replace them as necessary. If the fork legs are bent slightly they can usually be straightened.

4. Measure the free-length of the spring and replace it if collapsed, worn, or damaged.

ASSEMBLY

1. Assembly is basically the reverse order of disassembly.

2. Lubricate the suspension arm with grease and apply engine oil to the dust seal.

3. Lubricate the assembly when the assembly process is complete, by applying grease through the grease fitting using an automotive type grease gun.

STEERING STEM ASSEMBLY

Bearing Adjustment

1. The steering stem bearings are un-

Honda 4-Stroke Singles

caged #6 steel balls. They are adjusted by means of a ring nut beneath the upper triple clamp.

2. To check the bearing adjustment, support the front wheel off the ground. Grasp the fork sliders with both hands.

3. Attempt to move the forks by pulling out on the sliders. If play or movement can be felt, the bearings are too loosely adjusted or worn.

4. Turn the forks slowly from the lock-to-lock. Movement should be smooth, silent, and effortless. If any binding or uneven movement is felt, the balls or the races are either too tightly adjusted, unlubricated, or are worn. If the steering feels uniformly stiff, the bearings are too tightly adjusted. If any noise is noted, the bearings are damaged, or some are missing.

5. With the front wheel off the ground, release the front forks from a few degrees off the centered position. The forks should fall freely to either side of their own weight. If they will not, the bearings are too tightly adjusted, the steering stem is bent, the races are extremely worn, or some of the bearings are missing.

6. Bearings can be adjusted with a hammer and punch or a pin wrench on the adjuster nut under the upper triple clamp after the triple clamp is removed. To do this, remove the handlebars; on CT/ST90 models remove the handlebar clamp lever by removing the cotter pin and nut from the bottom of the clamp under the lower triple clamp, and remove the handlebars. Remove the fork filler caps, loosen the two or three triple clamp pinch-bolts (if fitted) and remove the steering stem nut. Tap the underside of the triple clamp upward to remove it.

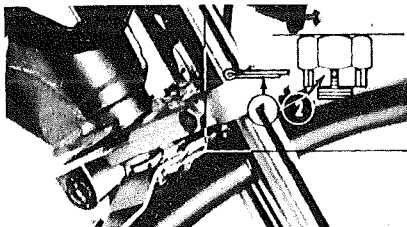

On CT/ST90 models, remove the handlebar clamp lever by removing the cotter pin (1) and the nut (2)

7. Tighten or loosen the adjusting nut a little at a time until the steering stem adjustment conforms to that outlined above.

8. If proper adjustment is not possible, the bearings and races will probably need to be replaced.

Removal

1. Remove the front wheel, fender forks, fuel tank, handlebars, and the handlebar clamp on ST90 models.

2. Disconnect the speedometer and tachometer cables from the instruments (if fitted). Remove the headlight lens and disconnect the wire harness. Remove the headlight shell, speedometer, and tachometer.

3. Loosen the upper triple clamp pinch-bolts (if fitted). Remove the steering stem nut and washer. Tap the upper triple clamp upward with a plastic mallet to remove it.

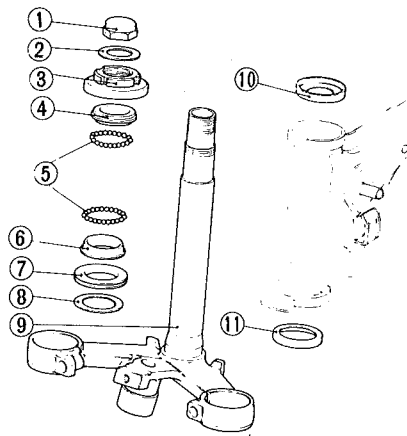

Typical steering stem assembly

1. Steering stem nut
2. Washer
3. Bearing adjuster nut
4. Upper race
5. Ball bearings
6. Lower race
7. Dust seal
8. Washer
9. Lower triple clamp and steering stem
10. Upper frame race
11. Lower frame race

4. Loosen the steering stem bearing adjuster nut with a pin wrench, then hold the steering stem up while unscrewing the adjuster nut the rest of the way off. Remove the steering stem top cone race and the balls from the top race.

5. Carefully pull the steering stem out from the bottom. Some of the ball bearings from the lower race will most likely fall out at this time so be prepared for this. Remove the rest of the balls from the lower race when the stem is removed.

6. Remove the bottom cone race, dust seal, and dust seal washer from the steering stem if they are to be replaced. If the steering stem has been damaged and is to be replaced, the upper and lower races and balls should also be replaced.

NOTE: A chisel is usually necessary to remove the lower cone race from the steering stem.

7. The bearing races in the frame are a press-fit and should not be removed unless replacement is necessary. Inspect them first. If replacement is necessary, the old races can be removed by reaching through the frame lug with a suitable punch and tapping the races out from the inside of the lug.

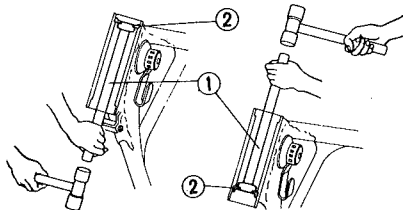

Using a bearing driver (1) to remove the bearing races in the frame

New races are installed using a suitable sized bushing driver; i.e., one which will drive the race squarely into its seat. Be certain that the race goes straight in.

These races can also be installed using a block of hardwood, of sufficient size to cover the race, in place of a bushing driver.

Inspection

1. Wash the bearings in a suitable solvent.

2. Clean all of the old grease from the bearing race surfaces, the steering stem, and the frame lug.

3. Inspect the bearing race surfaces. They must be clean and smooth. That is, free from any cracks, scoring, indentations, or rust. Run your finger around the bearing race surfaces. Note any roughness or ripples on the race surfaces. If either is damaged, replace both races and balls.

4. Check the balls themselves for rust, pitting, or flat spots. Replace the bearings as a set if any such damage occurs.

5. Check the dust seal for condition and replace if necessary.

6. Check the steering stem for cracks or a bent condition; this is especially important if the bike has been involved in a spill.

Installation

1. Install the dust seal washer, dust seal, and bottom cone race onto the steering stem. Use a good grade of bearing grease to coat the bottom cone race and the top race in the frame lug.

2. Embed the balls into the grease of the top frame race and the bottom cone race. Place a coat of grease on the two remaining races.

3. When the balls are in place, slip the steering stem through the frame lug and hold it in place, while refitting the top cone race and threading on the adjuster nut.

4. Tighten the adjuster nut, and move the steering stem back-and-forth to work the grease into the bearings, then back off the adjuster nut until the steering stem turns with ease, but has no play.

5. Install the upper triple clamp and fork tubes. Check that the stem moves freely of its own weight from 5°-10° off center; if not check for:

- a. Steering bearings too tight;
- b. Bent steering stem;
- c. Worn races or balls.

6. Install the flat washer, and steering stem nut.

7. Install the front wheel, front fender, headlight bracket, handlebars, and fuel tank.

REAR SHOCKS

No service to the rear shocks is possible. In the event of oil leaks, bent or broken plunger shaft, dented or otherwise damaged case, the shock absorber must be replaced.

If the shock absorbers are somewhat old, and one fails in the course of normal usage (such as an oil leak) it would be wise to replace both shocks to ensure equal damping characteristics.

To check a shock which is removed from the machine, place the bottom end

on the ground and use the weight of your body to compress it as much as possible. Release the shock and note its rebound behavior. If the shock returns quickly at first, then slowly returns to its normal length, it is serviceable. If it returns to its normal length all at once, it should be replaced.

SWING ARM

Inspection

1. Disconnect the drive chain. Remove the rear wheel.
2. Remove the shock absorbers and chain guard.
3. Measure the distance between the top and bottom shock absorber mounts on both sides. The two measurements must be identical, or the swing arm will have to be replaced.
4. Check that the rear wheel mounting plates are parallel.

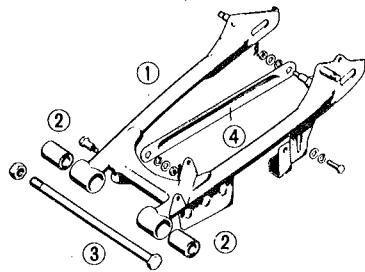

Typical swing arm assembly

1. Swing arm
2. Bushing
3. Pivot bolt
4. Brake anchor

5. Grasp the legs of the swing arm and attempt to move it from side-to-side. Any noticeable side-play will indicate that the swing arm bushings need replacement.

The swing arm is most likely to be damaged if the machine is operated for any length of time with a broken or otherwise defective shock absorber.

Removal and Installation

1. Proceed as above. Then remove the

swing arm pivot bolt nut, and pull the pivot bolt out from the right-side.

2. Remove the swing arm by pulling it straight back.

3. The swing arm should be inspected for cracks or fractures, especially around the welds.

After removal of the swing arm, the dust seals (if fitted), and bushings can be replaced. This should be done every 10,000 miles, or more often depending on how the machine is used, or if the bushings are worn (see "Inspection").

4. Remove the bushing(s), tapping them out with a hammer and punch. Once the bushings are removed, they should be replaced.

5. Lubricate new bushings with a good chassis grease. Press the bushings into the swing arm, then install the swing arm collar if fitted.

6. Install the swing arm on the machine. Grease and install the pivot bolt. After tightening the swing arm pivot bolt nut, move the swing arm up and down to ensure that movement is smooth and effortless.

Chassis Specifications

Part	Standard Specification mm (in.)	Serviceable Limit mm (in.)
Brake lining thickness	—	2.0 (0.079)
Axle bend (front and rear)	0.05 (0.002) max	0.2 (0.0079)
Wheel bearings		
axial play	0.05 (0.002)	0.2 (0.0079)
radial play	0.003-0.018 (0.0001-0.0007)	0.035 (0.0014)
Rim run-out	0.5 (0.020) max	2.0 (0.079)
Disc brake (125) disc run-out	—	0.3 (0.012)

Chassis Torque Specifications

Part	Torque (ft lbs)
<i>90-125 cc</i>	
Front axle nut	25.3-36.2
Rear axle nut	29.0-43.4
Swing arm pivot nut	25.3-36.2
Engine mounting bolts	14.5-21.7
Handlebar clamps	5.6-8.7
Steering stem nut	43.4-57.9
Triple clamp pinch-bolts	18.1-21.7
Rear shock mounting bolt	18.1-21.7
Rear shock mounting nut	21.7-29.0
Rear brake anchor	7.3-14.7
Rear sprocket nuts	14.5-21.7
Brake plate lever pinch-bolts (front)	5.6-8.0
(rear)	5.6-7.3
<i>50-70 cc</i>	
Axle nuts (front and rear)	29.0-39.8
Engine mounting bolts	14.5-21.7
Fork filler caps	25.4-32.6
Triple clamp pinch-bolts	14.5-21.7
Rear shock mounts	14.5-21.7
Swing arm pivot nut	25.4-32.6
Steering stem nut	43.4-65.1
Rear brake anchor	7.3-14.5
Handlebar clamp	5.9-8.7

General Torque Specifications

Part	Torque (ft lbs)
6 mm machine screws	5.0-7.2
6 mm hex bolts	5.8-8.7
8 mm hex bolts	13.0-18.1
10 mm hex bolts	21.7-28.9
6 mm flange bolts	7.2-10.1
8 mm flange bolts	17.4-21.7
10 mm flange bolts	21.7-28.9

① Unless otherwise specified

Honda 4-Stroke Singles

HONDA FOUR-STROKE SINGLES

1982 AND LATER MODEL INFORMATION

CB125S

Late model CB125 machines are identical to those described in the body of this section for models "1976 and Later" with the exception of the Capacitor Discharge Ignition which replaces the breaker points previously used.

Ignition timing is carried out in the same way: by rotating the base plate on which the pulse generator is mounted until the rotor "F" mark aligns with the timing indicator at idle or the full advance marks align with the indicator at 3,000 rpm and above.

CT110

The running gear of the CT110 is the same as

described for earlier "CT" models in the body of this section.

The CT110 powerplant belongs to the same engine family detailed in sections headed "90cc models" although a number of refinements have been made.

Exact procedures for this engine are outlined in the ATC70-125 section under the "110/125" heading.

Important differences are outlined below.

Engine Oil

Quantity: 1.1 qts./1.0 L during routine change.

Grade: SAE 10W-40 or equivalent service rated "SE" or "SF".

Tune-Up Specifications

Spark plug: DR8HS

Plug gap: 0.6-0.7mm/0.024-0.028 in.

Valve clearance: 0.07mm/0.003 in.

Compression: 178 ± 22 psi

Idle speed: 1300 rpm

Carburetor float level: 10.7mm/0.43 in.

Ignition timing: Remove the timing inspection cap on the front of the left crankcase cover. At idle, the "F" mark on the rotor should align with the timing index mark. Adjustments can be made by rotating the pulse generator base plate.

ENGINE AND TRANSMISSION SPECIFICATIONS

	110 cc Models	
	Standard (mm/in.)	Serviceable limit (mm/in.)
CYLINDER HEAD		
Cam journal OD		
R	17.927-17.938/0.7058-0.7062	17.90/0.705
L	25.977-25.930/1.0204-1.0209	25.88/1.019
Cam lobe height	24.90-24.98/0.980-0.983	24.6/0.97
Rocker arm ID	10.000-10.015/0.3937-0.3943	10.10/0.398
Rocker arm shaft OD	9.972-9.987/0.3926-0.3932	9.92/0.391
Rocker arm-to-shaft clearance	—	0.08/0.003
Cylinder head warpage	—	0.10/0.004
Valve spring free-length		
Inner	26.5/1.04	24.0/0.94
Outer	31.8/1.25	28.5/1.12
Valve stem OD		
Intake	5.455-5.465/0.2148-0.2152	5.44/0.214
Exhaust	5.430-5.445/0.2138-0.2144	5.41/0.213
Valve guide ID (In&Ex)	5.475-5.485/0.2157-0.2161	5.53/0.218
Stem-to-guide clearance		
Intake	—	0.08/0.003
Exhaust	—	0.10/0.004
Valve face width	1.2-1.5/0.05-0.06	1.8/0.07
Valve seat width	1.0/0.04	1.6/0.06
Cam hole ID		
R	18.000-18.018/0.7087-0.7094	18.05/0.711
L	26.000-26.020/1.0236-1.0244	26.05/1.026
Cam bearing clearance		
R	—	0.12/0.005
L	—	0.16/0.006

Honda 4-Stroke Singles

ENGINE AND TRANSMISSION SPECIFICATIONS

	110 cc Models	
	Standard (mm/in.)	Serviceable limit (mm/in.)
CYLINDER AND PISTON		
Cylinder ID	52.020-52.030/2.0480-2.0484	52.07/2.050
Taper	—	0.05/0.002
Out-of-round	—	0.05/0.002
Piston OD	51.970-51.990/2.0461-2.0468	5.180/2.039
Wrist pin bore	15.002-15.008/0.5906-0.5909	15.04/0.592
Wrist pin OD	14.994-15.000/0.5903-0.5906	14.96/0.589
Piston-to-pin clearance	0.002-0.014/0.0001-0.0006	0.02/0.001
Ring-to-groove clearance		
Top	0.015-0.050/0.006-0.0020	0.12/0.005
Second	0.010-0.045/0.0004-0.0018	0.12/0.005
Ring end-gap		
Top, second	0.10-0.25/0.004-0.010	0.50/0.02
Oil	0.30-0.90/0.012-0.035	—
Con rod small end ID	15.016-15.034/0.5912-0.5919	15.05/0.593
TRANSMISSION		
Sub-transmission		
Idle shaft OD	13.000-13.011/0.5118-0.5122	12.95/0.510
Drive sprocket bushing A		
OD	21.960-21.993/0.8646-0.8659	21.90/0.862
ID	19.992-20.025/0.7871-0.7884	19.94/0.785
Shift fork ID	42.000-42.025/1.6535-1.6545	42.1/1.66
Shift drum OD	41.950-41.975/1.6516-1.6526	41.8/1.65
Fork-to-drum clearance	0.025-0.075/0.0010-0.0030	0.10/0.004
Drum groove width	6.1-6.2/0.240-0.244	6.4/0.25
Fork finger width	5.96-6.04/0.234-0.238	5.70/0.224
Gear ID		
C1, C3	14.000-14.027/0.5512-0.5522	14.10/0.555
M2	18.000-18.018/0.7087-0.7094	18.08/0.712
M4	20.000-20.021/0.7874-0.7882	20.10/0.791
Shaft OD		
C1, M4	13.966-13.984/0.5498-0.5506	13.93/0.548
M2	17.966-17.984/0.7073-0.7080	17.93/0.706
C3	19.966-19.984/0.7861-0.7868	19.93/0.785
Drive sprocket bushing B		
ID	19.992-20.025/0.7871-0.7884	19.94/0.785
OD	21.960/21.993/0.8646-0.8659	21.90/0.862
CRANKSHAFT		
Run-out	—	0.10/0.004
Con rod big end side clearance	0.05-0.30/0.002-0.012	0.8/0.03
Con rod small end radial clearance	0-0.008/0-0.0003	0.05/0.002